

System x3630 M4 (E5-2400 v2) Product Guide (withdrawn product)

The System x3630 M4 server offers a cost-effective high-capacity storage solution with exceptional energy-smart design, leadership virtualization, and powerful systems management. It supports the latest Intel Xeon processor E5-2400 v2 product family and high-density memory designs with twelve DDR3 DIMM slots. This 2U server consolidates storage and server into one system, offers easy management, and saves floor space and power consumption, costing less money than traditional enterprise offerings. Designed with redundancy, flexible subsystems, and a wider range of configuration options, the x3630 M4 also offers an innovative Feature on Demand (FoD) design for an easier upgrade path.

Suggested use: Collaboration/email applications, light databases, virtualization/cloud, virtual desktops, web serving, and virtual storage.

The following figure shows the System x3630 M4.



Figure 1. The System x3630 M4

Did you know?

The System x3630 M4 server is designed to provide exceptional value and flexibility to meet general business or storage-intensive requirements with up to 56 TB of storage space in a dense 2U form factor and 80 PLUS Platinum certified power supplies. The flexible onboard Ethernet solution provides two standard integrated Gigabit Ethernet ports and two additional integrated Gigabit Ethernet ports with an optional software FoD upgrade without needing to buy additional hardware. Comprehensive systems management tools with the next-generation Integrated Management Module II (IMM2) make it easy to deploy, integrate, service, and manage.

Key features

Backed by Lenovo worldwide service and support, the x3630 M4 is developed, quality-tested, and certified by Lenovo, the leading vendor in technology patents for 20 years running. System x® advancements in scalability, reliability, and performance can help your business innovate and thrive. With more flexible configuration options, energy-efficient components, and robust systems management tools, the x3630 M4 is an innovative design by Lenovo that can deliver business value over the long term.

Scalability and performance

The x3630 M4 offers numerous features to boost performance, improve scalability, and reduce costs:

- The Intel Xeon processor E5-2400 v2 product family improves productivity by offering affordable dual-socket system performance with up to 10-core processors, up to 25 MB of L3 cache, and one QPI interconnect link of up to 8 GTps.
- Up to two processors, 20 cores, and 40 threads maximize the concurrent execution of multithreaded applications.
- Intelligent and adaptive system performance with Intel Turbo Boost Technology 2.0 allows processor cores to run at maximum speeds during peak workloads by temporarily going beyond processor thermal design power (TDP).
- Intel Hyper-Threading Technology boosts performance for multithreaded applications by enabling simultaneous multithreading within each processor core, up to two threads per core.
- Intel Virtualization Technology integrates hardware-level virtualization hooks that allow operating system vendors to better use the hardware for virtualization workloads.
- Intel Advanced Vector Extensions (AVX) improve floating point performance for compute-intensive technical and scientific applications.
- Up to 384 GB of memory capacity via 12 DIMM slots with 32 GB LRDIMMs.
- Up to 1600 MHz memory speeds with two DIMMs per channel running at 1600 MHz to help maximize system performance.
- The server offers up to four integrated Gigabit Ethernet ports with convenient Feature on Demand upgrade process that does not require the purchasing of an additional hardware.
- The server offers PCI Express 3.0 I/O expansion capabilities that improve the theoretical maximum bandwidth by almost 100% (8 GTps per link using 128b/130b encoding) compared to the previous generation of PCI Express 2.0 (5 GTps per link using 8b/10b encoding).
- With Intel Integrated I/O Technology, the PCI Express (PCIe) controller is integrated into the Intel Xeon processor E5 family, thereby reducing I/O latency and increasing overall system performance.
- Up to fourteen 3.5-inch hot-swap drive bays provide maximum internal storage density of up to 56 TB in a 2U form factor.

Availability and serviceability

The x3630 M4 provides many features to simplify serviceability and increase system uptime:

- The server offers Chipkill, memory mirroring, and memory rank sparing for redundancy in the event of a non-correctable memory failure to prevent an unplanned outage.
- Tool-less cover removal provides easy access to upgrades and serviceable parts, such as processor, memory, and adapter cards.
- The server offers simple-swap or hot-swap drives supporting affordable software RAID and advanced hardware RAID redundancy for data protection and greater system uptime.
- The server offers up to two redundant hot-swap power supplies and three dual-motor non-hot-swap redundant fans to provide cost-efficient availability for applications.

- The light path diagnostics panel and individual light path LEDs quickly lead the technician to failed (or failing) components. This panel simplifies servicing, speeds up problem resolution, and helps improve system availability.
- Predictive Failure Analysis (PFA) detects when system components (processors, memory, hard disk drives, fans, and power supplies) operate outside of standard thresholds and generates proactive alerts in advance of a possible failure, therefore increasing uptime.
- Solid-state drives (SSDs) offer significantly better reliability than traditional mechanical HDDs for greater uptime.
- The built-in Integrated Management Module II (IMM2) continuously monitors system parameters, triggers alerts, and performs recovery actions in case of failure, to minimize downtime.
- Built-in diagnostics using Dynamic Systems Analysis (DSA) Preboot speeds up troubleshooting tasks to reduce service time.
- Three-year customer replaceable unit and on-site limited warranty, next business day 9x5. Optional service upgrades available.

Manageability and security

Powerful systems management features simplify local and remote management of the x3630 M4:

- The server includes an Integrated Management Module II (IMM2) to monitor server availability and perform remote management.
- An integrated industry-standard Unified Extensible Firmware Interface (UEFI) enables improved setup, configuration, and updates, and simplifies error handling.
- Integrated Trusted Platform Module (TPM) V1.2 support enables advanced cryptographic functionality, such as digital signatures and remote attestation.
- IBM Systems Director is included for proactive systems management. It offers comprehensive systems management tools that help increase uptime, reduce costs, and improve productivity through advanced server management capabilities.
- Industry-standard AES NI support provides faster and stronger encryption.
- Intel Execute Disable Bit functionality can help prevent certain classes of malicious buffer overflow attacks when combined with a supporting operating system.
- Intel Trusted Execution Technology provides enhanced security through hardware-based resistance to malicious software attacks, allowing an application to run in its own isolated space protected from all other software running on a system.

Energy efficiency

The x3630 M4 offers the following energy-efficiency features to save energy, reduce operational costs, increase energy availability, and contribute to a green environment:

- Energy-efficient planar components help lower operational costs.
- 80 PLUS Platinum certified power supplies enable greater energy savings while providing flexibility to meet your business needs.
- The Intel Xeon processor E5-2400 v2 product family offers better performance over the previous generation, while fitting into the same TDP limits.
- Intel Intelligent Power Capability powers individual processor elements on and off as needed, to reduce power draw.
- Low-voltage Intel Xeon processors draw less energy to satisfy the demands of power and thermally constrained data centers and telecommunication environments.
- Low-voltage 1.35 V DDR3 memory RDIMMs consume 19% less energy compared to 1.5 V DDR3 RDIMMs.
- Solid state drives (SSDs) consume as much as 80% less power than traditional spinning HDDs.

- The server uses hexagonal ventilation holes, a part of Calibrated Vectors Cooling™ technology. Hexagonal holes can be grouped more densely than round holes, providing more efficient airflow through the system.
- IBM Systems Director Active Energy Manager™ provides advanced data center power notification and management to help achieve lower heat output and reduced cooling needs.

Components and connectors

The following figure shows the front of the server with eight 3.5-inch drive bays.

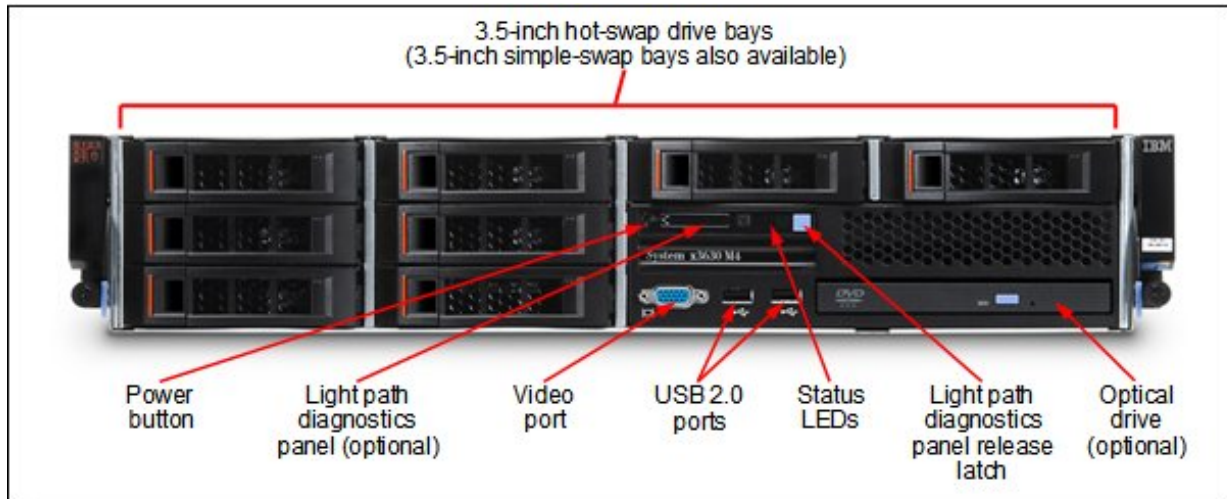

Figure 2. Front view of the System x3630 M4 with eight drive bays

The following figure shows the front of the server with twelve 3.5-inch drive bays.

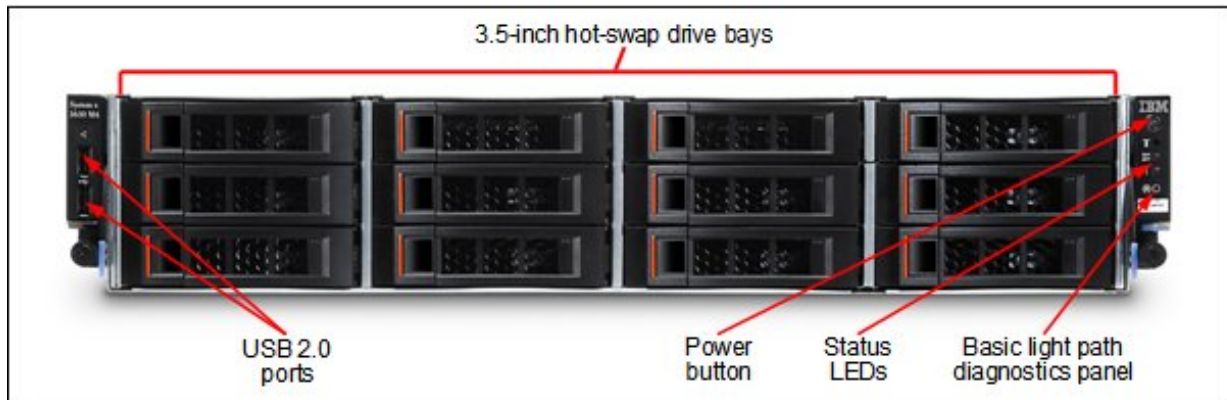

Figure 3. Front view of the System x3630 M4 with twelve drive bays

The following figure shows the rear of the server without the optional rear HDD cage upgrade.

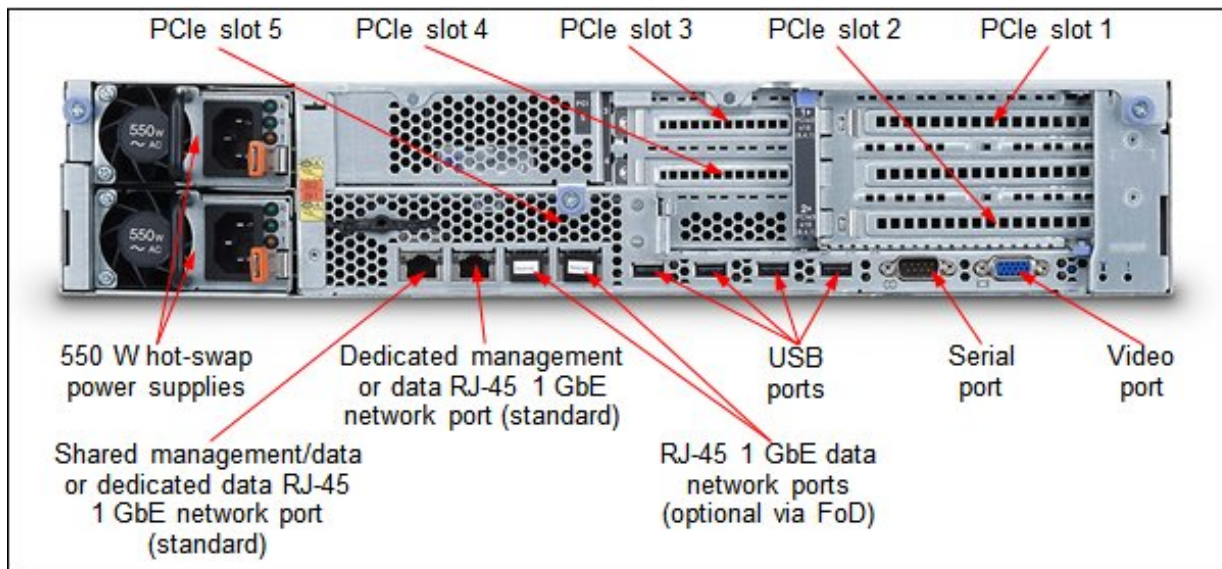

Figure 4. Rear view of the System x3630 M4 without the rear HDD cage

The following shows the rear of the server with the optional rear HDD cage upgrade.

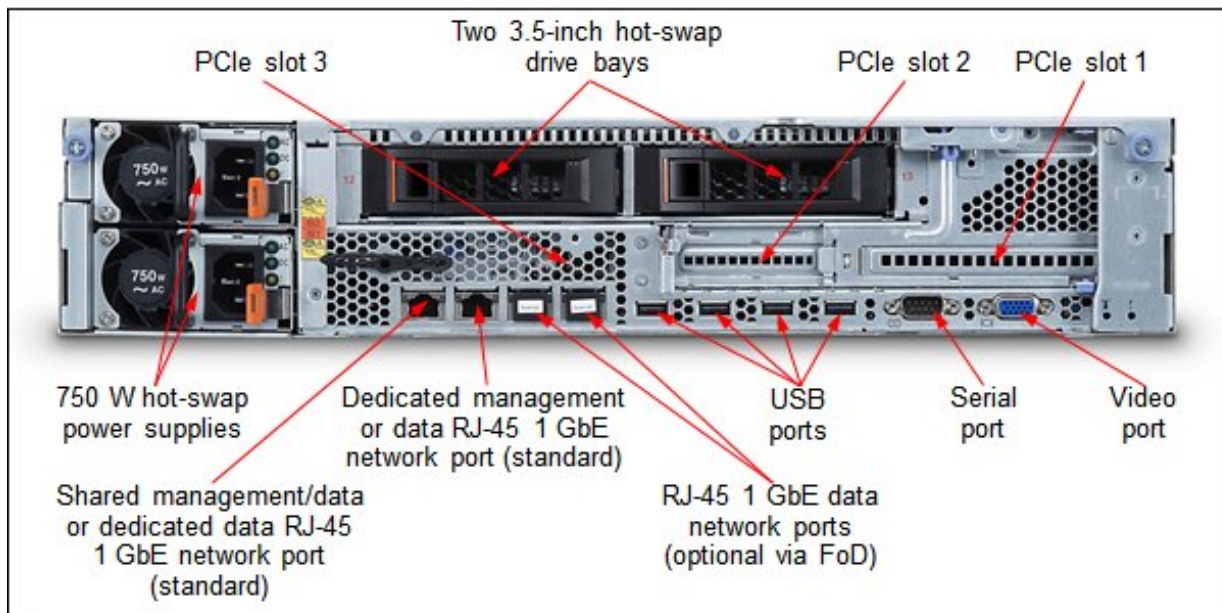

Figure 5. Rear view of the System x3630 M4 with the rear HDD cage

The following figure shows the locations of key components inside the server.

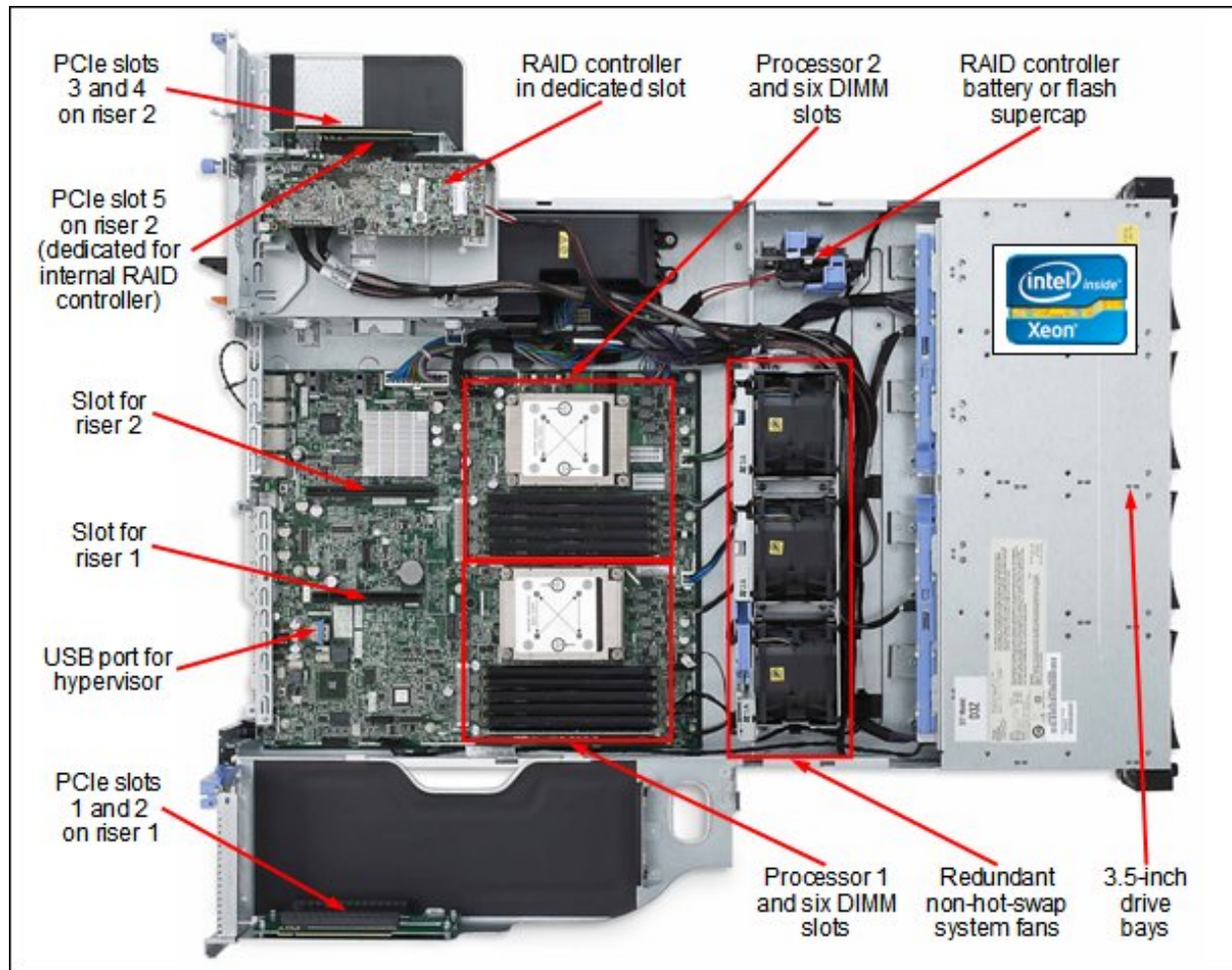

Figure 6. Inside view of the System x3630 M4

System specifications

The following table lists the system specifications.

Table 1. System specifications

Components	Specification
Machine type	7158
Form factor	2U rack.
Processor	Up to two Intel Xeon processor E5-2400 v2 product family processors with 10 cores (up to 2.4 GHz), eight or six cores (up to 2.5 GHz), four cores (up to 2.4 GHz), one QPI link up to 8.0 GTps, up to 1600 MHz memory speed, up to 25 MB L3 cache.
Chipset	Intel C600 series.
Memory	Up to 12 DIMM sockets (six DIMMs per processor). LRDIMMs, RDIMMs, and UDIMMs are supported, but memory types cannot be intermixed. DIMM speeds are up to 1600 MHz.
Memory maximums	With LRDIMMs: Up to 384 GB with 12x 32 GB RDIMMs and two processors With RDIMMs: Up to 192 GB with 12x 16 GB RDIMMs and two processors With UDIMMs: Up to 96 GB with 12x 8 GB UDIMMs and two processors
Memory protection	ECC, Chipkill, memory mirroring, and memory rank sparing.
Disk drive bays	Up to eight 3.5-inch SATA simple-swap drive bays, up to eight 3.5-inch SAS/SATA hot-swap drive bays, or up to fourteen 3.5-inch SAS/SATA hot-swap drive bays.
Maximum internal storage	Up to 84 TB with 6 TB 3.5-inch NL SAS/SATA HS HDDs, up to 32 TB with 4 TB 3.5-inch SATA SS HDDs, or up to 22.4 TB with 1.6 TB GB 3.5-inch SATA HS SSDs. An intermix of SAS/SATA is supported.
RAID support	JBOD (Linux only) or RAID 0 and 1 with C105. RAID 0, 1, and 10 with M1115 or M5110. Upgrades to RAID 5 and 50 are available for M1115. Upgrades to RAID 5 and 50 are available for M5110 (zero-cache; 512 MB battery-backed cache; 512 MB, 1 GB, or 2 GB flash-backed cache). Upgrade to RAID 6 or 60 is available for M5110 with caches.
Optical drive bays	One, for models with up to eight 3.5-inch drive bays. Support for optional DVD-ROM or Multiburner.
Tape drive bays	Optional, for models with up to eight 3.5-inch drive bays. Tape Enablement Kit is required to support the internal tape drive. Support for optional DDS5 or DDS6 USB tape drives is available.
Network interfaces	Up to four integrated Gigabit Ethernet 1000BASE-T RJ-45 ports with the onboard Intel I350-CM2 controller (two ports enabled, and an additional two ports require the optional software FoD upgrade to enable them).
Ports	Two USB 2.0 and one DB-15 video (not available on storage-rich models) port on the front. Four USB 2.0, one DB-15 video, one DB-9 serial, and four RJ-45 GbE network ports on the rear. Two internal USB ports (one for embedded hypervisor, one for internal USB tape drive).
Cooling	Calibrated Vectored Cooling with three redundant non-hot-swap fans; each fan has two motors.
Power supply	Up to two redundant hot-swap 550 W HE AC, 750 W HE AC, or 900 W HE AC power supplies (all AC power supplies are 80 PLUS Platinum certified), or up to two redundant hot-swap 750 W HE DC power supplies.
Hot-swap parts	Hard drives (hot-swap models), power supplies.

Components	Specification
I/O expansion slots	<p>Up to five slots in models with up to 12 drive bays, depending on the riser cards installed. The slots are as follows:</p> <ul style="list-style-type: none"> Slot 1: PCIe 3.0 x16 (x8-wired), optional PCIe 3.0 x16 (x16-wired); full-height, full-length Slot 2: PCIe 3.0 x16 (x8-wired); full-height, half-length (not present if optional x16-wired slot 1 riser is used) Slot 3: PCIe 3.0 x16 (x8-wired), optional PCIe 3.0 x16 (x16-wired); low-profile, half-length (the second processor is required to use this slot) Slot 4: PCIe 3.0 x16 (x8-wired); low-profile, half-length (not present if optional x16-wired slot 3 riser is used, the second processor is required to use this slot) Slot 5: PCIe 3.0 x8 (x4-wired); dedicated slot for ServeRAID adapter; standard on hardware RAID models, optional on software RAID models <p>Up to three slots in models with 14 drive bays, depending on the riser cards installed. The slots are as follows:</p> <ul style="list-style-type: none"> Slot 1: PCIe 3.0 x8 (x8-wired), optional PCIe 3.0 x16 (x16-wired); full-height, half-length Slot 2: PCIe 3.0 x8 (x8-wired); low-profile, half-length (not present if an optional x16-wired slot 1 riser is used) Slot 3: PCIe 3.0 x8 (x4-wired), optional PCIe 3.0 x8 (x8-wired); dedicated slot for ServeRAID adapter (x8-wired slot requires the second processor, x4-wired slot does not require the second processor)
Systems management	UEFI, Integrated Management Module II (IMM2), Predictive Failure Analysis, light path diagnostics (basic standard, advanced optional), Automatic Server Restart, IBM Systems Director and IBM Systems Director Active Energy Manager, and ServerGuide. Optional IMM Advanced FoD Upgrade for remote presence (graphics, keyboard and mouse, and virtual media).
Security features	Power-on password, administrator's password, and Trusted Platform Module (TPM).
Video	Matrox G200eR2 with 16 MB memory integrated into the IMM2. Maximum resolution is 1600x1200 at 75 Hz with 16 M colors.
Operating systems supported	Microsoft Windows Server 2012 R2, 2012, 2008 R2, and 2008 (x64), Red Hat Enterprise Linux 5 and 6, SUSE Linux Enterprise Server 11, VMware vSphere (ESXi) 5.0, 5.1, and 5.5.
Limited warranty	Three-year customer-replaceable unit and on-site limited warranty with 9x5/NBD.
Service and support	Optional service upgrades (country-specific) are available through Lenovo Services offerings: 4-hour or 2-hour response time, 8 hours fix time, one-year or two-year warranty extension, remote technical support for Lenovo hardware and selected Lenovo and third-party (Microsoft, Linux, VMware) software.
Dimensions	Height: 86 mm (3.4 in.), width: 447 mm (17.6 in.), depth: 749 mm (29.5 in.)
Weight	Minimum configuration: 16.4 kg (36.2 lb), maximum: 28.2 kg (62.2 lb)

The x3630 M4 servers are shipped with the following items:

- Registration flyer
- Statement of Limited Warranty
- Important Notices
- Rack Installation Instructions
- Documentation CD containing *Installation and User's Guide*
- Rail kit (static rails, non-sliding; no cable management arm included)
- One 2.8m, 10A/100-250V, C13 to IEC 320-C14 rack power cable

Standard models

The following table lists the standard models.

Table 2. Standard models

Model number*	Intel Xeon processor† (two maximum)	Memory (RDIMMs)	RAID controller	Drive bays (std / max)	Drives	Onboard NIC (std / max)	I/O slots (std / max)	Optical drive	Power supply (std / max)
Models announced January 2014									
7158A3x	1x E5-2403 v2 4C 1.8GHz 10MB 1333MHz 80W	1x 4GB 1600MHz§	C105	4x 3.5" SS / 4	Open bay	2x GbE / 4	2 / 5	Optional	1x 550 W HS / 2
7158A5x	1x E5-2403 v2 4C 1.8GHz 10MB 1333MHz 80W	1x 4GB 1600MHz§	C105 8-Pack	8x 3.5" HS / 8	Open bay	2x GbE / 4	2 / 5	Optional	1x 550 W HS / 2
7158B3x	1x E5-2407 v2 4C 2.4GHz 10MB 1333MHz 80W	1x 4GB 1600MHz§	C105 8-Pack	8x 3.5" SS / 8	Open bay	2x GbE / 4	2 / 5	Optional	1x 550 W HS / 2
7158B5x	1x E5-2407 v2 4C 2.4GHz 10MB 1333MHz 80W	1x 4GB 1600MHz§	M1115	12x 3.5" HS / 14	Open bay	2x GbE / 4	5 / 5	None	1x 750 W HS / 2
7158C3x	1x E5-2420 v2 6C 2.2GHz 15MB 1600MHz 80W	1x 8GB 1600MHz	M5110	8x 3.5" HS / 8	Open bay	2x GbE / 4	5 / 5	Optional	1x 550 W HS / 2
7158D3x	1x E5-2430 v2 6C 2.5GHz 15MB 1600MHz 80W	1x 8GB 1600MHz	M5110 512MB Flash	12x 3.5" HS / 14	Open bay	2x GbE / 4	5 / 5	None	1x 750 W HS / 2
7158F5x	1x E5-2440 v2 8C 1.9GHz 20MB 1600MHz 95W	1x 8GB 1600MHz	M5110 512MB Flash	8x 3.5" HS / 8	Open bay	2x GbE / 4	5 / 5	Optional	1x 550 W HS / 2
7158G3x	1x E5-2450 v2 8C 2.5GHz 20MB 1600MHz 95W	1x 8GB 1600MHz	M5110 1GB Flash	8x 3.5" HS / 8	Open bay	2x GbE / 4	5 / 5	Optional	1x 750 W HS / 2

* x in the Model number represents a region-specific letter (for example, the EMEA model number is 7158A3G, and the US model number is 7158A3U). Ask a Lenovo representative for specifics.

† Processor detail: Processor quantity and model, cores, core speed, L3 cache, memory speed, TDP.

§ The standard DIMM is rated at 1600 MHz, but operates at up to 1333 MHz to match the processor memory speed. Actual memory speed maximums depend on several factors, as described in "Memory options".

Express models

The following table lists the express models.

Table 3. Express models

Model number	Intel Xeon processors† (two maximum)	Memory (RDIMMs)	RAID controller	Drive bays (std / max)	Drives	Onboard NIC (std / max)	I/O slots (std / max)	Optical drive	Power supply (std / max)
United States									
7158EDU	1x E5-2403 v2 4C 1.8GHz 10MB 1333MHz 80W	1x 8GB 1600MHz§	M5110	8x 3.5" HS / 8	Open bay	2x GbE / 4	5 / 5	Multi burner	1x 550 W HS / 2
7158EEU	1x E5-2420 v2 6C 2.2GHz 15MB 1600MHz 80W	1x 8GB 1600MHz	M5110	8x 3.5" HS / 8	Open bay	2x GbE / 4	5 / 5	Multi burner	1x 550 W HS / 2
7158EFU	1x E5-2440 v2 8C 1.9GHz 20MB 1600MHz 95W	1x 8GB 1600MHz	M5110 1GB Flash	12x 3.5" HS / 14	Open bay	2x GbE / 4	5 / 5	None	2x 750 W HS / 2
Canada									
7158EGU	2x E5-2440 v2 8C 1.9GHz 20MB 1600MHz 95W	4x 16GB 1600MHz	M5110 1GB Flash	12x 3.5" HS / 14	Open bay	2x GbE / 4	5 / 5	None	2x 750 W HS / 2
Europe									
7158EEG	1x E5-2420 v2 6C 2.2GHz 15MB 1600MHz 80W	1x 8GB 1600MHz	M5110	8x 3.5" HS / 8	Open bay	2x GbE / 4	5 / 5	Multi burner	1x 550 W HS / 2
7158EHG	1x E5-2407 v2 4C 2.4GHz 10MB 1333MHz 80W	1x 8GB 1600MHz§	M5110	8x 3.5" HS / 8	Open bay	2x GbE / 4	5 / 5	Multi burner	1x 550 W HS / 2
Central and Eastern Europe (CEE) and Middle East and Africa (MEA)									
7158EJG	1x E5-2407 v2 4C 2.4GHz 10MB 1333MHz 80W	1x 8GB 1600MHz§	M1115	8x 3.5" HS / 8	Open bay	2x GbE / 4	5 / 5	Multi burner	1x 550 W HS / 2
Russia/Commonwealth of Independent States (CIS)									
7158EEG	1x E5-2420 v2 6C 2.2GHz 15MB 1600MHz 80W	1x 8GB 1600MHz	M5110	8x 3.5" HS / 8	Open bay	2x GbE / 4	5 / 5	Multi burner	1x 550 W HS / 2
7158EHG	1x E5-2407 v2 4C 2.4GHz 10MB 1333MHz 80W	1x 8GB 1600MHz§	M5110	8x 3.5" HS / 8	Open bay	2x GbE / 4	5 / 5	Multi burner	1x 550 W HS / 2
Latin America (Brazil only)									
7158EQU	1x E5-2420 v2 6C 2.2GHz 15MB 1600MHz 80W	1x 8GB 1600MHz	M1115	8x 3.5" HS / 8	2x 1TB 7.2K	2x GbE / 4	5 / 5	Multi burner	1x 550 W HS / 2
7158ERU	1x E5-2420 v2 6C 2.2GHz 15MB 1600MHz 80W	1x 8GB 1600MHz	M1115	8x 3.5" HS / 8	2x 600GB 15K	2x GbE / 4	5 / 5	Multi burner	1x 550 W HS / 2
7158ETU	1x E5-2440 v2 8C 1.9GHz 20MB 1600MHz 95W	1x 8GB 1600MHz	M5110	8x 3.5" HS / 8	2x 1TB 7.2K	2x GbE / 4	5 / 5	Multi burner	1x 550 W HS / 2
7158EUU	1x E5-2440 v2 8C 1.9GHz 20MB 1600MHz 95W	1x 8GB 1600MHz	M5110	8x 3.5" HS / 8	2x 600GB 15K	2x GbE / 4	5 / 5	Multi burner	1x 550 W HS / 2
Japan									
7158EZJ	1x E5-2407 v2 4C 2.4GHz 10MB 1333MHz 80W	1x 4GB 1600MHz§	M5110 512MB Flash	8x 3.5" HS / 8	Open bay	2x GbE / 4	5 / 5	Optional	1x 550 W HS / 2

† Processor detail: Processor quantity and model, cores, core speed, L3 cache, memory speed, TDP.

§ The standard DIMM is rated at 1600 MHz, but operates at up to 1333 MHz to match the processor memory speed. Actual memory speed maximums depend on several factors, as described in "Memory options".

Processor options

The x3630 M4 (E5-2400 v2) supports the processor options listed in the following table. The server supports up to two Intel Xeon processor E5-2400 v2 product family processors. This table shows which server models have each processor standard. If there is no corresponding *where used* model for a particular processor, then this processor is only available through CTO.

Table 4. Processor options

Part number*	Feature code†	Description	Standard models where used
00J6381	A4LM / A4L6	Intel Xeon Processor E5-2403 v2 4C 1.8GHz 10MB Cache 1333MHz 80W	A3x, A5x
00J6382	A4LL / A4L5	Intel Xeon Processor E5-2407 v2 4C 2.4GHz 10MB Cache 1333MHz 80W	B3x, B5x
00Y7437	A4LQ / A4LE	Intel Xeon Processor E5-2418L v2 6C 2.0GHz 15MB Cache 1333MHz 50W	-
00J6383	A4LK / A4L4	Intel Xeon Processor E5-2420 v2 6C 2.2GHz 15MB Cache 1600MHz 80W	C3x
00Y7438	A4LR / A4LC	Intel Xeon Processor E5-2428L v2 8C 1.8GHz 20MB Cache 1600MHz 60W	-
00J6384	A4LJ / A4L3	Intel Xeon Processor E5-2430 v2 6C 2.5GHz 15MB Cache 1600MHz 80W	D3x
00J6388	A4LP / A4L8	Intel Xeon Processor E5-2430L v2 6C 2.4GHz 15MB Cache 1600MHz 60W	-
00J6385	A4LH / A4LB	Intel Xeon Processor E5-2440 v2 8C 1.9GHz 20MB Cache 1600MHz 95W	F5x
00Y7439	A4LS / A4LD	Intel Xeon Processor E5-2448L v2 10C 1.8GHz 25MB Cache 1600MHz 70W	-
00J6386	A4LG / A4L2	Intel Xeon Processor E5-2450 v2 8C 2.5GHz 20MB Cache 1600MHz 95W	G3x
00J6389	A4LN / A4L7	Intel Xeon Processor E5-2450L v2 10C 1.7GHz 25MB Cache 1600MHz 60W	-
00J6387	A4LF / A4L0	Intel Xeon Processor E5-2470 v2 10C 2.4GHz 25MB Cache 1600MHz 95W	-

* The option for the second processor includes two additional system fans.

† The first feature code is for the first processor; the second feature code is for the second processor.

** These processors only support single processor configurations and are available only through CTO or special bid.

Memory options

Lenovo DDR3 memory is compatibility tested and tuned for optimal System x performance and throughput. Lenovo memory specifications are integrated into the light path diagnostics for immediate system performance feedback and optimum system uptime. From a service and support standpoint, Lenovo memory automatically assumes the system warranty, and Lenovo provides service and support worldwide.

The x3630 M4 supports DDR3 memory. The server supports up to six DIMMs when one processor is installed, and up to 12 DIMMs when two processors are installed. Each processor has three memory channels, and there are two DIMMs per channel. The following rules apply when selecting the memory configuration:

- Mixing different types of memory (UDIMMs, RDIMMs, and LRDIMMs) is not supported.
- The maximum number of ranks supported per one channel is eight (with the exception of Load Reduced DIMMs, where more than eight ranks are supported because one quad-rank LRDIMM provides the same electrical load on a memory bus as a single-rank RDIMM).
- The maximum quantity of DIMMs that can be installed in a server depends on the number of processors (six DIMMs with one processor installed, 12 DIMMs with two processors installed)
- All DIMMs in all processor memory channels operate at the same speed, which is determined as the lowest value of:

- The memory speed supported by the specific processor.
- The lowest of maximum operating speeds for the selected memory configuration that depends on the rated speed, operating voltage, and quantity of DIMMs per channel, as shown under the "Maximum operating speed" section in Table 5.

The following memory protection technologies are supported:

- ECC
- Chipkill (for x4-based memory DIMMs)
- Memory mirroring
- Memory rank sparing

Chipkill works only in independent channel mode (the default is operational mode) and supports only x4-based memory DIMMs.

If memory mirroring is used, then DIMMs must be installed in pairs (a minimum of one pair per each processor, and a maximum of two pairs per processor), and both DIMMs in a pair must be identical in type and size.

If memory rank sparing is used, then two single-rank or dual-rank DIMMs must be installed per populated channel (the DIMMs do not need to be identical). In rank sparing mode, one rank of a DIMM in each populated channel is reserved as spare memory. The size of a rank varies depending on the DIMMs installed.

Chipkill, memory mirroring, and memory rank sparing modes are mutually exclusive. Only one operational memory mode can be enabled on a server, and it is a system-wide setting.

The following table shows the characteristics of the supported DIMMs. Table cells highlighted with a gray background indicate when the combination of DIMM voltage and the number of DIMMs per channel still allows the DIMMs to operate at a rated speed.

Table 5. Maximum memory speeds

Specification	DIMM type		UDIMM				RDIMM		LRDIMM
Rank	Dual rank		Single rank		Dual rank		Quad rank		
Part number	00D5012 (4 GB) 00D5016 (8 GB)		00D5024 (4 GB) 00D5036 (8 GB)		00D5044 (8 GB) 46W0672 (16 GB)		46W0761 (32 GB)		
Rated speed	1600 MHz		1600 MHz		1600 MHz		1866 MHz		
Rated voltage	1.35 V		1.35 V		1.35 V		1.5 V		
Operating voltage	1.35 V	1.5 V	1.35 V	1.5 V	1.35 V	1.5 V	1.5 V		
Max quantity*	12	12	12	12	12	12	12		
Largest DIMM	8 GB	8 GB	8 GB	8 GB	16 GB	16 GB	32 GB		
Max memory capacity	96 GB	96 GB	96 GB	96 GB	192 GB	192 GB	384 GB		
Max memory at rated speed	None**	None**	None**	96 GB	None**	192 GB	None**		
Maximum operating speed (MHz)									
1 DIMM per channel	1333 MHz	1333 MHz	1333 MHz	1600 MHz	1333 MHz	1600 MHz	1333 MHz		
2 DIMMs per channel	1066 MHz	1066 MHz	1333 MHz	1600 MHz	1333 MHz	1600 MHz	1066 MHz		

* Maximum quantity supported is shown for two processors installed. When one processor is installed, the maximum quantity supported is a half of what is shown.

** Rated speed is not supported. Memory DIMMs always operate at speeds lower than rated.

The following table lists the memory options available for the x3630 M4 (E5-2400 v2) server.

Table 6. Memory options

Part number	Feature code	Description	Maximum supported	Standard models where used
UDIMMs				
00D5012	A3QB	4GB (1x4GB, 2Rx8, 1.35V) PC3L-12800 CL11 ECC DDR3 1600MHz LP UDIMM	12 (6 per CPU)	-
00D5016	A3QC	8GB (1x8GB, 2Rx8, 1.35V) PC3L-12800 CL11 ECC DDR3 1600MHz LP UDIMM	12 (6 per CPU)	-
RDIMMs				
00D5024	A3QE	4GB (1x4GB, 1Rx4, 1.35V) PC3L-12800 CL11 ECC DDR3 1600MHz LP RDIMM	12 (6 per CPU)	A3x, A5x, B3x, B5x
00D5036	A3QH	8GB (1x8GB, 1Rx4, 1.35V) PC3L-12800 CL11 ECC DDR3 1600MHz LP RDIMM	12 (6 per CPU)	-
00D5044	A3QK	8GB (1x8GB, 2Rx8, 1.35V) PC3L-12800 CL11 ECC DDR3 1600MHz LP RDIMM	12 (6 per CPU)	C3x, D3x, F5x, G3x
46W0672	A3QM	16GB (1x16GB, 2Rx4, 1.35V) PC3L-12800 CL11 ECC DDR3 1600MHz LP RDIMM	12 (6 per CPU)	-
LRDIMMs				
46W0761	A47K	32GB (1x32GB, 4Rx4, 1.5V) PC3-14900 CL13 ECC DDR3 1866MHz LP LRDIMM	12 (6 per CPU)	-

Internal storage

The x3630 M4 server supports the following internal storage configurations:

- Four 3.5-inch SATA simple-swap drive bays
- Eight 3.5-inch SATA simple-swap drive bays
- Eight 3.5-inch SAS/SATA hot-swap drive bays
- Twelve 3.5-inch SAS/SATA hot-swap drive bays
- Fourteen 3.5-inch SAS/SATA hot-swap drive bays

In addition, four and eight bay models support the installation of either an internal optical drive or an internal tape drive.

The following figure shows some of these configurations.



Figure 7. Internal drive configurations

Standard models ship with four or eight 3.5-inch SATA simple-swap drive bays or eight 3.5-inch SAS/SATA hot-swap drive bays. Storage-rich models ship with twelve 3.5-inch SAS/SATA hot-swap drive bays, and they can also be upgraded to fourteen 3.5-inch hot-swap drive bay models with the optional rear drive cage assembly. The following table shows the internal storage expansion options that are available.

Table 7. Internal storage expansion options

Part number	Feature code	Description	Maximum supported	Standard models where used
00Y7548	A56T	x3630 M4 Rear Cage Assembly, 2 x 3.5" Hot Swap	1	-
00AL388	A4SF	x3630 M4 Rear Fan Kit	1	-
00D9051	A1ZL	x3630 M4 ODD Cage assembly	1	A3x, A5x, B3x, C3x, F5x, G3x
90Y6370	A1ZM	USB Tape Drive Cage assembling kit	1	-

Option 00Y7548 is used to upgrade standard (see Table 2) or custom (CTO or special bid) models with twelve 3.5-inch hot-swap drive bays to fourteen 3.5-inch hot-swap drive bays. This option must be ordered together with the option 00AL388, x3630 M4 Rear Fan Kit.

Option 00Y7548 contains the drive backplane, drive cage, signal and data cables, and two 1U riser cards: PCIe Riser Card for slot 1 (1 x8 FH/HL + 1 x8 LP Slots) v2 and PCIe Riser Card 2 (1 x4 LP for Slotless RAID) v2. These 1U riser cards replace the standard 2U riser cards used in the models with twelve 3.5-inch hot-swap drive bays, limiting the maximum number of I/O slots to three (for more information, see the "I/O expansion options" section).

Option 00D9051 upgrades any four or eight bay model with an internal optical drive bay (for DVD-ROM or Multiburner). This option includes one USB cable and one power cable. The optical drive is ordered separately. This option is mutually exclusive with 90Y6370, Tape Drive Cage assembly.

Note: Option 00D9051, x3630 M4 ODD Cage assembly comes standard with every four or eight bay standard model listed in Table 2.

Option 90Y6370 upgrades any four or eight bay model with an internal tape drive bay (for DDS5 or DDS6 tape drives). This option includes one USB cable and one power cable. The tape drive is ordered separately. This option is mutually exclusive with 90Y6370, ODD Cage assembly.

Controllers for internal storage

The following table lists the RAID controllers and HBAs and the additional options used for the internal disk storage of the x3630 M4 server.

Table 8. RAID controllers and HBAs for internal storage

Part number	Feature code	Description	Maximum supported	Standard models where used
Adapters				
None#	A2VA	ServeRAID C105	1	A3x, A5x, B3x
81Y4492	A1XL	ServeRAID H1110 SAS/SATA Controller	1	-
81Y4448	A1MZ	ServeRAID M1115 SAS/SATA Controller	1	B5x
81Y4481	A347	ServeRAID M5110 SAS/SATA Controller	1	C3x, D3x, F5x, G3x
46M0912	3876	6Gb Performance Optimized HBA	1	-
46C8988	A3MW	N2115 SAS/SATA HBA	1	-
Upgrades				
90Y4349§	A2V7	8-pack SATA Enabler	1	A5x, B3x
81Y4542	A1X1	ServeRAID M1100 Series Zero Cache/RAID 5 Upgrade	1	-
81Y4544	A1X2	ServeRAID M5100 Series Zero Cache/RAID 5 Upgrade	1	-
81Y4484	A1J3	ServeRAID M5100 Series 512MB Cache/RAID 5 Upgrade	1	-
81Y4487	A1J4	ServeRAID M5100 Series 512MB Flash/RAID 5 Upgrade	1	D3x, F5x
81Y4559	A1WY	ServeRAID M5100 Series 1GB Flash/RAID 5 Upgrade	1	G3x
47C8670	A4G6	ServeRAID M5100 Series 2GB Flash/RAID 5 Upgrade	1	-
81Y4508	A22E	ServeRAID M5100 Series Battery Kit	1*	-
81Y4546	A1X3	ServeRAID M5100 Series RAID 6 Upgrade	1†	-
90Y4273	A2MC	ServeRAID M5100 Series Performance Accelerator	1†	-
90Y4318	A2MD	ServeRAID M5100 Series SSD Caching Enabler	1†	-

The ServeRAID C105 is an onboard software RAID controller.

§ An FoD upgrade for ServeRAID C105 that supports eight SATA HDDs.

* The ServeRAID M5100 Series Battery Kit (81Y4508) is only supported with ServeRAID M5100 Series 512MB Cache/RAID 5 Upgrade (81Y4484).

† The ServeRAID M5100 Series RAID 6 Upgrade (81Y4546), Performance Accelerator (90Y4273), and Caching Enabler (90Y4318) are Features on Demand (FoD) upgrades that activate the feature on all M5100 Series controllers installed in a server. These FoD upgrades require a RAID 5 Upgrade with caches (81Y4484, 81Y4487, 81Y4559, or 47C8670).

The internal hardware RAID controller is installed into a dedicated PCIe slot (slot 3 for models with 14 drive bays or slot 5 for models with up to 12 drive bays). See Table 13 and Table 14 (PCI riser card options) for more details.

The following table lists drive types and internal drive bay configurations supported by the RAID controllers and HBAs (SAS HDDs include both SAS and NL SAS HDDs, and SATA HDDs include both SATA and NL SATA HDDs).

Table 9. Drive types and internal drive bay configurations supported by the RAID controllers and HBAs

RAID controller	Drive type	8x 3.5-in. hot-swap	12x 3.5-in. hot-swap	14x 3.5-in. hot-swap	4x 3.5-in. simple-swap	8x 3.5-in. simple-swap
ServeRAID C105	SAS HDD	No support	No support	No support	No support	No support
	SATA HDD	Yes*	No support	No support	Yes	Yes*
	SATA SSD	No support	No support	No support	No support	No support
ServeRAID H1110	SAS HDD	No support	No support	No support	Yes	No support
	SATA HDD	No support	No support	No support	Yes	No support
	SATA SSD	No support	No support	No support	No support	No support
ServeRAID M1115	SAS HDD	Yes	Yes	Yes	Yes	Yes
	SATA HDD	Yes	Yes	Yes	Yes	Yes
	SATA SSD	Yes	Yes	Yes	Yes	Yes
ServeRAID M5110	SAS HDD	Yes	Yes	Yes	Yes	Yes
	SATA HDD	Yes	Yes	Yes	Yes	Yes
	SATA SSD	Yes	Yes	Yes	Yes	Yes
6Gb Performance Optimized HBA N2115	SAS HDD	Yes	Yes	Yes	Yes	Yes
	SATA HDD	Yes	Yes	Yes	Yes	Yes
	SATA SSD	Yes	Yes	Yes	Yes	Yes

* Requires an FoD upgrade for ServeRAID C105 to support eight SATA HDDs (8-pack SATA Enabler, part number 90Y4349).

The ServeRAID C105 onboard controller has the following specifications:

- Eight internal 3 Gbps SATA ports
- Up to 3 Gbps throughput per port
- Supports up to eight (up to four standard, with an additional four with optional 8-pack enabler, 90Y4349) SATA HDDs (SAS not supported)
- Supports hot-swap and simple-swap drives
- Supports JBOD mode (Linux only) or RAID 0, 1, and 10
- Support for up to eight volumes
- Support for virtual drive sizes greater than 2 TB
- Fixed stripe unit size of 64 KB
- Support for MegaRAID Storage Manager management software

The ServeRAID H1110 adapter has the following specifications:

- Four internal 6 Gbps SAS/SATA ports
- Up to 6 Gbps throughput per port
- One x4 mini-SAS internal connector (SFF-8087)
- Based on the LSI SAS2004 6 Gbps RAID on Chip (ROC) controller
- PCIe 2.0 x4 host interface
- Supports RAID 0, 1, 1E, and 10
- Connects to up to four SAS or SATA drives (SAS expanders are not supported.)

The ServeRAID M1115 SAS/SATA Controller has the following specifications:

- Eight internal 6 Gbps SAS/SATA ports
- Up to 6 Gbps throughput per port
- Two x4 mini-SAS internal connectors (SFF-8087)
- Supports connections to SAS/SATA drives and SAS Expanders
- Supports RAID levels 0, 1, and 10
- Supports RAID levels 5 and 50 with optional M1100 Series RAID 5 upgrades
- PCIe 2.0 x8 host interface
- Based on the LSI SAS2008 6 Gbps ROC controller

The ServeRAID M5110 SAS/SATA Controller has the following specifications:

- Eight internal 6 Gbps SAS/SATA ports
- Up to 6 Gbps throughput per port
- Two x4 mini-SAS internal connectors (SFF-8087)
- Supports connections to SAS/SATA drives and SAS Expanders
- Supports RAID levels 0, 1, and 10
- Supports RAID levels 5 and 50 with optional M5100 Series RAID 5 upgrades
- Supports RAID 6 and 60 with the optional M5100 Series RAID 6 Upgrade
- Supports 512 MB battery-backed cache or 512 MB or 1 GB flash-backed cache
- Support for SSD performance optimization with the optional M5100 Series Performance Accelerator and SSD Caching Enabler
- PCIe 3.0 x8 host interface
- Based on the LSI SAS2208 6 Gbps ROC controller

The 6Gb Performance Optimized HBA has the following specifications:

- Eight internal 6 Gbps SAS/SATA ports
- Up to 6 Gbps throughput per port
- Two x4 mini-SAS internal connectors (SFF-8087)
- Supports connections to SAS/SATA HDDs and SATA SSDs
- Optimized for SSD performance
- No RAID support
- PCIe 2.0 x8 host interface
- Based on the LSI SAS2008 6 Gbps ROC controller

The N2115 SAS/SATA HBA has the following specifications:

- Eight internal 6 Gbps SAS/SATA ports
- Up to 6 Gbps throughput per port
- Two x4 mini-SAS internal connectors (SFF-8087)
- Supports connections to SAS/SATA HDDs and SATA SSDs
- Optimized for SSD performance
- No RAID support
- PCIe 3.0 x8 host interface
- Based on the LSI SAS2308 6 Gbps controller

For more information, see the list of Lenovo Press Product Guides in the RAID adapters category:
<http://lenovopress.com/servers/options/raid>

Internal drive options

The following table lists hard drive options for internal disk storage of the x3630 M4 server.

Table 10. Drive options for internal storage

Part number	Feature code	Description	Maximum supported
3.5" SAS Hot-Swap HDDs			
49Y6092	A3DV	300GB 15K 6Gbps SAS 3.5" G2HS HDD	14
49Y6102	A3DX	600GB 15K 6Gbps SAS 3.5" G2HS HDD	14
3.5" SAS Hot-Swap Self-encrypting drives (SEDs)			
00W1543	A4AJ	4TB 7.2K 6Gbps NL SAS 3.5" G2HS SED	14
3.5" NL SAS Hot-Swap HDDs			
90Y8567	A26M	1TB 7.2K 6Gbps NL SAS 3.5" G2HS HDD	14
90Y8572	A2U0	2TB 7.2K 6Gbps NL SAS 3.5" G2HS HDD	14
90Y8577	A2R2	3TB 7.2K 6Gbps NL SAS 3.5" G2HS HDD	14
49Y6210	A4AF	4TB 7.2K 6Gbps NL SAS 3.5" G2HS HDD	14
00ML213	AS78	6TB 7.2K 6Gbps NL SAS 3.5" G2HS 512e HDD	14
3.5" NL SATA Hot-Swap HDDs			
81Y9786	A22Y	500GB 7.2K 6Gbps NL SATA 3.5" G2HS HDD	14
81Y9790	A22P	1TB 7.2K 6Gbps NL SATA 3.5" G2HS HDD	14
81Y9794	A22T	2TB 7.2K 6Gbps NL SATA 3.5" G2HS HDD	14
00FN113	A5VD	2TB 7.2K 6Gbps NL SATA 3.5" G2HS 512e HDD	14
81Y9798	A22S	3TB 7.2K 6Gbps NL SATA 3.5" G2HS HDD	14
00FN128	A5VF	3TB 7.2K 6Gbps NL SATA 3.5" G2HS 512e HDD	14
49Y6002	A3W9	4TB 7.2K 6Gbps NL SATA 3.5" G2HS HDD	14
00FN143	A5VH	4TB 7.2K 6Gbps NL SATA 3.5" G2HS 512e HDD	14
00FN173	A5VM	6TB 7.2K 6Gbps NL SATA 3.5" G2HS 512e HDD	14
3.5" NL SATA Simple-Swap HDDs			
81Y9802	A22U	500GB 7.2K 6Gbps NL SATA 3.5" G2SS HDD	8
81Y9806	A22X	1TB 7.2K 6Gbps NL SATA 3.5" G2SS HDD	8
81Y9810	A22W	2TB 7.2K 6Gbps NL SATA 3.5" G2SS HDD	8
00FN118	A5VE	2TB 7.2K 6Gbps NL SATA 3.5" G2SS 512e HDD	8
00FN148	A5VJ	4TB 7.2K 6Gbps NL SATA 3.5" G2SS 512e HDD	8
3.5" SAS Hot-Swap SSDs - Enterprise			
00W1311	A4N8	400GB SAS 3.5" MLC HS Enterprise SSD	14
00W1316	A4N9	800GB SAS 3.5" MLC HS Enterprise SSD	14
3.5" SATA Hot-Swap SSDs - Enterprise			
00AJ485	A56H	S3700 400GB SATA 3.5" MLC HS Enterprise SSD for System x	14
00AJ490	A56J	S3700 800GB SATA 3.5" MLC HS Enterprise SSD for System x	14
3.5" SATA Hot-Swap SSDs - Enterprise Value			
00AJ435	A57F	120GB SATA 3.5" MLC HS Enterprise Value SSD	14
00AJ440	A57G	240GB SATA 3.5" MLC HS Enterprise Value SSD	14

Part number	Feature code	Description	Maximum supported
00AJ445	A57H	480GB SATA 3.5" MLC HS Enterprise Value SSD	14
00AJ450	A57J	800GB SATA 3.5" MLC HS Enterprise Value SSD	14
00AJ460	A56C	S3500 120GB SATA 3.5" MLC HS Enterprise Value SSD	14
00AJ465	A56D	S3500 240GB SATA 3.5" MLC HS Enterprise Value SSS	14
00AJ470	A56E	S3500 480GB SATA 3.5" MLC HS Enterprise Value SSD	14
00AJ475	A56F	S3500 800GB SATA 3.5" MLC HS Enterprise Value SSD	14
00FN288	A5U7	S3500 1.6TB SATA 3.5" MLC HS Enterprise Value SSD	14
3.5" SATA Hot-Swap SSDs - Entry			
00FN352	AS0K	240GB SATA 3.5" MLC HS Entry SSD	14
00FN357	AS0L	480GB SATA 3.5" MLC HS Entry SSD	14
00FN362	AS0M	960GB SATA 3.5" MLC HS Entry SSD	14

Internal backup units

The server supports the internal backup options listed in the following table. The USB Tape Drive Cage assembling kit, part number 90Y6370, is required to support these tapes internally. The internal tape drive is connected to the dedicated internal USB port on a system board.

Table 11. Internal tape drives

Part number	Feature code	Description	Maximum supported
90Y6370	A1ZM*	USB Tape Drive Cage assembling kit	1
46C5399	5711*	DDS Generation 5 USB Tape Drive	1
39M5636	5395*	DDS Generation 6 USB Tape Drive	1

* No longer available via CTO

Optical drives

The server supports the optical drive options listed in the following table. The installation of optical drive may require x3630 M4 ODD Cage assembly, part number 00D9051. Standard models of x3630 M4 with four or eight HDDs ship with the ODD Cage assembly installed. Server models with twelve 3.5-inch HDDs do not support an internal optical drive.

Table 12. Optical drives

Part number	Feature code	Description	Maximum supported	Standard models where used
46M0901	4161	UltraSlim Enhanced SATA DVD-ROM	1	-
46M0902	4163	UltraSlim Enhanced SATA Multi-Burner	1	-

UltraSlim Enhanced SATA DVD-ROM (part number 46M0901) supports the following media and speeds for reading:

- CD-ROM 24X
- CD-R 24X
- CD-RW 24X
- DVD-ROM (4.7 GB) 8X
- DVD-ROM (dual layer, 8.5 GB) 8X
- DVD-R (4.7 GB) 8X
- DVD-R (dual layer, 8.5 GB) 8X
- DVD+R (4.7 GB) 8X
- DVD+R (dual layer, 8.5 GB) 8X
- DVD-RW (4.7 GB) 8X
- DVD+RW (4.7 GB) 8X
- DVD-RAM (4.7 GB) 5X

UltraSlim Enhanced SATA Multi-Burner (46M0902) supports the same media and speeds for reading as DVD-ROM (46M0901). This drive also supports the following media and speeds for writing:

- CD-R 24X
- CD-RW 24X
- DVD-R (4.7 GB) 8X
- DVD-R (dual layer, 8.5 GB) 6X
- DVD+R (4.7 GB) 8X
- DVD+R (dual layer, 8.5 GB) 6X
- DVD-RW (4.7 GB) 6X
- DVD+RW (4.7 GB) 8X
- DVD-RAM (4.7 GB) 5X

I/O expansion options

The server supports up to five PCIe slots with different riser cards installed into two riser sockets on the system planar (one riser socket supports the installation of one riser card). There are two types of riser cards: 2U risers and 1U risers. 2U risers are used in x3630 M4 models that do not have the rear HDD cage assembly (see Figure 4). 1U risers are used in models with the rear HDD cage assembly installed (see Figure 5). See Figure 4 and Figure 5 for slot locations and numbering.

Note: You cannot use 1U risers in models without the rear HDD cage. You cannot use 2U risers in models with the rear HDD cage assembly installed.

The slot form factors with 2U risers (models without the rear HDD cage assembly) are as follows:

- Slot 1: PCIe 3.0 x16 (x8-wired), optional PCIe 3.0 x16 (x16-wired); full-height, full-length
- Slot 2: PCIe 3.0 x16 (x8-wired); full-height, half-length (not present if optional x16-wired slot 1 riser is used)
- Slot 3: PCIe 3.0 x16 (x8-wired), optional PCIe 3.0 x16 (x16-wired); low-profile, half-length (the second processor is required to use this slot)
- Slot 4: PCIe 3.0 x16 (x8-wired); low-profile, half-length (not present if optional x16-wired slot 3 riser is used, the second processor is required to use this slot)
- Slot 5: PCIe 3.0 x8 (x4-wired); dedicated slot for ServeRAID adapter; standard on hardware RAID models, optional on software RAID models

Note: Standard models with software RAID (ServeRAID C105) ship with one 2U riser supplying slots 1 and 2 (slots 3, 4, and 5 are not present). Standard models with hardware RAID adapters (ServeRAID M1115 or M5110) ship with two 2U risers supplying all five slots. See Table 13 for details.

The slot form factors with 1U risers (models with the rear HDD cage assembly) are as follows:

- Slot 1: PCIe 3.0 x8 (x8-wired), optional PCIe 3.0 x16 (x16-wired); full-height, half-length
- Slot 2: PCIe 3.0 x8 (x8-wired); low-profile, half-length (not present if an optional x16-wired slot 1 riser is used)
- Slot 3: PCIe 3.0 x8 (x4-wired), optional PCIe 3.0 x8 (x8-wired); dedicated slot for ServeRAID adapter (x8-wired slot requires the second processor, x4-wired slot does not require the second processor)

Note: The 3.5" Hot Swap Cage Assembly, Rear, 2 x 3.5" option, part number 00Y7548, ships with two 1U risers supplying x8-wired slots 1 and 2 and x4-wired slot 3. See Table 14 for details.

The following two tables lists the I/O riser card options, the 2U riser options and the 1U riser options.

Table 13. 2U I/O riser card options

Part number	Feature code	Description	Maximum supported	Standard models where used
2U Riser 1 option (supplies slots 1 and 2)				
None*	A4LY	PCIe Riser Card 1 (1 x8 FH/FL + 1 x8 FH/HL Slots) v2	1	A3x, A5x, B3x, B5x, C3x, D3x, F5x, G3x
00Y7550	A4TC	PCIe Riser Card 1 (1 x16 FH/FL Slot) v2	1	-
2U Riser 2 option (supplies slot 3, 4, and 5)				
00AL310	A4LZ	PCIe Riser Card 2 (2 x8 LP Slots + 1 x4 LP for Slotless RAID) v2	1	B5x, C3x, D3x, F5x, G3x
00Y7551	A4TD	PCIe Riser Card 2 (1 x16 LP Slot + 1 x4 LP for Slotless RAID) v2	1	-

* This riser card is installed in all standard models. It can also be used in CTO or special bid models.

Table 14. 1U I/O riser card options

Part number	Feature code	Description	Maximum supported	Standard models where used
1U Riser 1 option (supplies slots 1 and 2)				
None†	A4LU	PCIe Riser Card for slot 1 (1 x8 FH/HL + 1 x8 LP Slots) v2	1	-
None*	A4LV	PCIe Riser Card 1 (1 x16 FH/HL Slot) for Graphic card v2	1	-
1U Riser 2 option (supplies slot 3)				
None†	A4LW	PCIe Riser Card 2 (1 x4 LP for Slotless RAID) v2	1	-
00Y7549	A4LX	PCIe Riser Card 2 (1 x8 LP for Slotless RAID) v2	1	-

† These riser cards come standard with the 3.5" Hot Swap Cage Assembly, Rear, 2 x 3.5" option (00Y7548).

* This riser card is only available through CTO or special bid models.

Network adapters

The x3630 M4 supports up to four integrated Gigabit Ethernet ports (two enabled standard, and two enabled optionally with the FoD upgrade). Integrated NIC has the following features:

- An Intel I350-CM2 chip
- Up to four Gigabit Ethernet ports (two enabled standard, and two enabled optionally with the 90Y9314 FoD upgrade)
- NIC Teaming (load balancing and failover)
- Ethernet Features:
 - 1 Gb Ethernet IEEE 802.3, 802.3u, and 802.3ab PHY specifications compliant
 - Integrated PHY for 10/100/1000 Mbps for multispeed, full, and half-duplex auto-negotiation
 - IEEE 802.3x and 802.3z compliant flow control support with software-controllable Rx thresholds and Tx pause frames
 - Automatic cross-over detection function (MDI/MDI-X)
 - IEEE 1588 protocol and 802.1AS implementation
 - IEEE802.3az - Energy Efficient Ethernet (EEE)
 - Full wake up support
 - Advanced Power Management (APM) support
 - Advanced Configuration and Power Interface (ACPI) specification v2.0c
 - Magic packet wake-up enable
- I/O Virtualization Features:
 - Eight transmit (Tx) and receive (Rx) queue pairs per port
 - Flexible port partitioning: 32 virtual functions (VF) with four ports or 16 VFs with two ports
 - Rx/Tx round-robin scheduling
 - Traffic isolation and traffic steering
 - Virtual machine (VM) to VM packet forwarding (packet loopback)
 - MAC and VLAN anti-spoofing
 - Malicious driver detection
 - Storm control
 - Per-pool statistics, off loads, and jumbo support
 - Independent Function Level Reset (FLR) for physical and virtual functions
 - IEEE 802.1q Virtual Local Area Network (VLAN) support with VLAN tag insertion, stripping, and packet filtering for up to 4096 VLAN tags
 - IEEE 802.1q advanced packet filtering
 - Mirroring rules
 - Support for simple VEPA
 - VF promiscuous modes
- Stateless offload and performance features:
 - TCP/UDP, IPv4 checksum offloads (Rx/ Tx/Large-send); extended Tx descriptors
 - IPv6 support for IP/TCP and IP/UDP receive checksum offload
 - Tx TCP segmentation offload (IPv4, IPv6)
 - Transmit Segmentation Offloading (TSO)
 - Interrupt throttling control
 - Legacy and Message Signal Interrupt (MSI)
 - Message Signal Interrupt Extension (MSI-X)
 - Receive Side Scaling (RSS) for Windows
 - Scalable I/O for Linux environments (IPv4, IPv6, TCP/UDP)
 - Support for packets up to 9.5 KB (jumbo frames)

The following table lists additional supported network adapters.

Table 15. Network adapters

Part number	Feature code	Description	Maximum supported
40 Gb Ethernet / FDR InfiniBand			
00D9550	A3PN	Mellanox ConnectX-3 40GbE / FDR IB VPI Adapter	4
10 Gb Ethernet			
44T1370	A5GZ	Broadcom NetXtreme 2x10GbE BaseT Adapter	4
94Y5180	A4Z6	Broadcom NetXtreme Dual Port 10GbE SFP+ Adapter	4*
00JY830	A5UU	Emulex VFA5 2x10 GbE SFP+ Adapter and FCoE/iSCSI SW	4*
None	AS3M	Emulex VFA5 2x10 GbE SFP+ Integrated Adapter	4*
00JY820	A5UT	Emulex VFA5 2x10 GbE SFP+ PCIe Adapter	4*
00JY824	A5UV	Emulex VFA5 FCoE/iSCSI SW for PCIe Adapter (FoD) (Features on Demand upgrade for 00JY820 and feature AS3M)	4
49Y7960	A2EC	Intel X520 Dual Port 10GbE SFP+ Adapter	4*
49Y7970	A2ED	Intel X540-T2 Dual Port 10GBaseT Adapter	4
81Y3520	AS73	Intel X710 2x10GbE SFP+ Adapter	4*
00D9690	A3PM	Mellanox ConnectX-3 10 GbE Adapter	4*
42C1800	5751	QLogic 10Gb CNA	4*
90Y4600	A3MR	QLogic 8200 Dual Port 10GbE SFP+ VFA	4*
00Y5624	A3MT	QLogic 8200 VFA FCoE/iSCSI License (FoD) (Features on Demand upgrade for 90Y4600)	4
47C9952	A47H	Solarflare SFN5162F 2x10GbE SFP+ Performant Adapter	4*
Integrated NIC upgrades			
90Y9314	A2GT	Intel I-350 Embedded Dual Port GbE Activation (FoD)	1
Gigabit Ethernet			
39Y6066	1485	Broadcom NetXtreme 1xGbE BaseT Adapter	4
42C1780	2995	Broadcom NetXtreme 2xGbE BaseT Adapter	4
90Y9370	A2V4	Broadcom NetXtreme I Dual Port GbE Adapter	4
90Y9352	A2V3	Broadcom NetXtreme I Quad Port GbE Adapter	4
49Y4230	5767	Intel Ethernet Dual Port Server Adapter I340-T2	4
49Y4240	5768	Intel Ethernet Quad Port Server Adapter I340-T4	4
00AG500	A56K	Intel I350-F1 1xGbE Fiber Adapter	4
00AG510	A56L	Intel I350-T2 2xGbE BaseT Adapter	4
00AG520	A56M	Intel I350-T4 4xGbE BaseT Adapter	4

* These adapters require SFP+ optical transceivers or DAC cables that must be purchased separately.

For more information, see the list of Lenovo Press Product Guides in the Ethernet Adapters category:
<http://lenovopress.com/servers/options/ethernet>

Storage host bus adapters

The following table lists storage HBAs supported by the x3630 M4 server.

Table 16. Storage adapters

Part number	Feature code	Description	Maximum supported
Fibre Channel - 16 Gb			
81Y1662	A2W6	Emulex 16Gb FC Dual-port HBA	4
81Y1655	A2W5	Emulex 16Gb FC Single-port HBA	4
00Y3341	A3KX	QLogic 16Gb FC Dual-port HBA	4
00Y3337	A3KW	QLogic 16Gb FC Single-port HBA	4
Fibre Channel - 8 Gb			
42D0494	3581	Emulex 8Gb FC Dual-port HBA	4
42D0485	3580	Emulex 8Gb FC Single-port HBA	4
42D0510	3579	QLogic 8Gb FC Dual-port HBA	4
42D0501	3578	QLogic 8Gb FC Single-port HBA	4
SAS			
46M0907	5982	6Gb SAS HBA	4
46C9010	A3MV	N2125 SAS/SATA HBA	2
00AE912	A5M0	N2225 SAS/SATA HBA	4
00AE916	A5M1	N2226 SAS/SATA HBA	1

For more information, see the list of Lenovo Press Product Guides in the Host bus adapters category: <http://lenovopress.com/servers/options/hba>

PCIe SSD adapters

The server supports the High IOPS SSD adapters listed in the following table.

Table 17. SSD adapters

Part number	Feature code	Description	Maximum supported
Enterprise			
00AE995	ARYP	1000GB Enterprise io3 Flash Adapter	4
00AE998	ARYQ	1300GB Enterprise io3 Flash Adapter	4
00JY001	ARYR	2600GB Enterprise io3 Flash Adapter	4
00JY004	ARYS	5200GB Enterprise io3 Flash Adapter	2
Enterprise Value			
00AE983	ARYK	1250GB Enterprise Value io3 Flash Adapter	4
00AE986	ARYL	1600GB Enterprise Value io3 Flash Adapter	4
00AE989	ARYM	3200GB Enterprise Value io3 Flash Adapter	4
00AE992	ARYN	6400GB Enterprise Value io3 Flash Adapter	2

Note: The io3 Flash Adapters cannot be factory installed; they are supported as field-installable options only. The server cannot be shipped with these adapters installed.

For more information, see the list of Lenovo Press Product Guides in the PCIe SSD Adapters category: <http://lenovopress.com/servers/options/ssdadapter>

GPU adapters

The server supports graphics processing units (GPUs) provided riser card 00Y7550 or FC A4LV is installed. The following table lists the supported GPUs.

Table 18. GPU adapters

Part number	Feature code	Description	Maximum supported
None*	A3WH	NVIDIA Quadro K600	1
None*	A3WJ	NVIDIA Quadro K2000	1

* This adapter can only be ordered through CTO or special bid.

The use of GPU adapters with 4x 3.5-inch or 8x 3.5-inch drive bay models requires installation of one or two 750 W power supplies. The use of GPU adapters with 12x 3.5-inch or 14x 3.5-inch drive bay models requires installation of one or two 900 W power supplies. 550 W power supplies are not supported with GPU adapters.

Power supplies

The server supports up to two redundant hot-swap 550 W AC, 750 W AC, 900 W AC, or 750 W DC high efficient power supplies. AC power supplies are 80 PLUS Platinum certified. Standard models come with one 550 W AC (models with up to eight drive bays) or 750 W AC (storage-rich models with up to 14 drive bays) hot-swap power supply.

The following table lists the power supply options. An AC hot-swap power supply option ships standard with one 2.8m, 10A/100-250V, C13 to IEC 320-C14 rack power cable.

Table 19. Power supplies

Part number	Feature code	Description	Maximum supported	Standard models where used
94Y6668	A1H6	System x 550W High Efficiency Platinum AC Power Supply	2	A3x, A5x, B3x, C3x, F5x
94Y6669	A1H5	System x 750W High Efficiency Platinum AC Power Supply	2	B5x, D3x, G3x
94Y6667	A2EB	System x 900W High Efficiency Platinum AC Power Supply	2	-
94Y7631	A39N	System x 750W High Efficiency -48 V DC Power Supply	2	-

Note: If you plan to use GPU adapters, refer to the "GPU adapters" section for the additional power supply selection guidelines.

Integrated virtualization

The server supports VMware ESXi installed on a USB memory key. The key is installed in a USB socket inside the server. The following table lists the virtualization options.

Table 20. Virtualization options

Part number	Feature code	Description	Maximum supported
41Y8298	A2G0	Blank USB Memory Key for VMware ESXi Downloads	1
41Y8311	A2R3	USB Memory Key for VMware ESXi 5.1	1
41Y8382	A4WZ	USB Memory Key for VMware ESXi 5.1 Update 1	1
41Y8385	A584	USB Memory Key for VMware ESXi 5.5	1

Systems management

The server contains Integrated Management Module II (IMM2), which provides advanced service-processor control, monitoring, and an alerting function. If an environmental condition exceeds a threshold or if a system component fails, the IMM2 lights LEDs to help you diagnose the problem, records the error in the event log, and alerts you to the problem. Optionally, the IMM2 also provides a virtual presence capability for remote server management capabilities.

The IMM2 provides remote server management through industry-standard interfaces:

- Intelligent Platform Management Interface (IPMI) Version 2.0
- Simple Network Management Protocol (SNMP) Version 3
- Common Information Model (CIM)
- Web browser

The optional Integrated Management Module Advanced Upgrade is required to enable the remote presence and blue-screen capture features. The remote presence feature provides the following functions:

- Remotely viewing video with graphics resolutions up to 1600x1200 at 75 Hz with up to 23 bits per pixel, regardless of the system state
- Remotely accessing the server using the keyboard and mouse from a remote client
- Mapping the CD or DVD drive, diskette drive, and USB flash drive on a remote client, and mapping ISO and diskette image files as virtual drives that are available for use by the server
- Uploading a diskette image to the IMM memory and mapping it to the server as a virtual drive

The blue-screen capture feature captures the video display contents before the IMM restarts the server when the IMM detects an operating system hang condition. A system administrator can use the blue-screen capture to assist in determining the cause of the hang condition. The following table lists the remote management option.

Table 21. Remote management option

Part number	Feature code	Description	Maximum supported
90Y3901	A1ML	Integrated Management Module Advanced Upgrade	1

In the default UEFI configuration, Ethernet port 2 is configured to be dedicated to remote access to the IMM2. If preferred, you can change the UEFI setting so that remote access to the IMM2 is via Port 1 and also accessible to the operating system. This setting is also useful if you do not have a dedicated management network. The following table shows this setting and its effect on the Ethernet ports.

Note: The IMM2 network must operate 100 Mbps full duplex. The IMM2 network connection does not support Gigabit Ethernet. In shared mode, the production Ethernet network on that port still operates at Gigabit speeds.

Table 22. UEFI settings for remote access to the IMM

UEFI mode	Ethernet Port 1	Ethernet Port 2	Ethernet Port 3 (optional)	Ethernet Port 4 (optional)
IMM network interface port dedicated (default)	Production Ethernet	IMM2 dedicated*	Production Ethernet	Production Ethernet
IMM network interface port shared	Shared - Production Gb Ethernet and IMM2*	Production Ethernet	Production Ethernet	Production Ethernet

* The IMM network is limited to 100 Mbps full duplex

Light path diagnostics panel

The light path diagnostics panel allows system engineers and administrators to easily and quickly diagnose hardware problems on the System x servers. If a failure occurs, a light is illuminated on the front panel of the server (level 1 light path) to alert the systems administrator that there is a problem. The pop-out light path diagnostics panel (light path level 2) has a light against the failed subsystem. This light directs the engineer or administrator directly to the failed component, which also has an illuminated LED near it (light path level 3), for example, the DIMM error LED on the system board.

x3630 M4 offers two variants of light path diagnostics: basic and advanced. All standard x3630 M4 models include basic functionality that provides light path levels 1 and 3. Advanced functionality is optional, and contains a pop-out panel that adds light path level 2. Storage-rich x3630 M4 servers (servers with 12 or 14 drive bays) only support basic light path.

The following figures show basic (level 1) and advanced (level 2) light path levels.

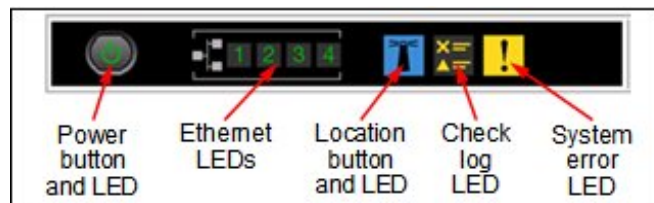

Figure 8. Basic (level 1) light path for models with eight drive bays

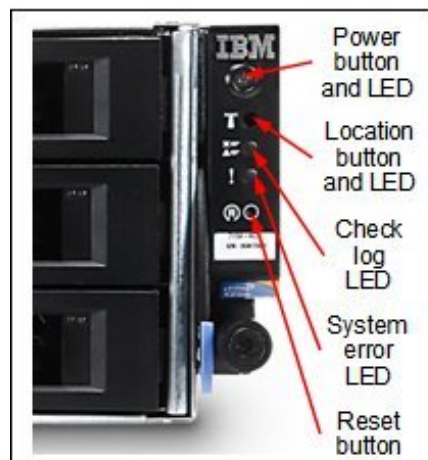

Figure 9. Basic (level 1) light path for storage-rich models

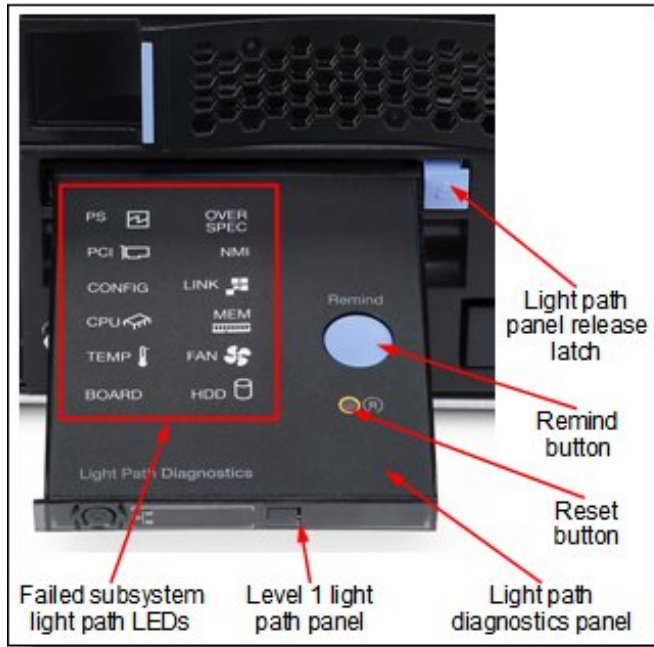

Figure 10. Advanced (level 2) light path for models with eight drive bays

The following table lists the advanced light path kit.

Table 23. Advanced light path kit

Part number	Feature code	Description	Maximum supported
90Y6533	A2U6	Lightpath Upgrade kit	1

Operating systems

The server supports the following operating systems:

- Microsoft Windows Server 2008 R2
- Microsoft Windows Server 2008, Datacenter x64 Edition
- Microsoft Windows Server 2008, Datacenter x86 Edition
- Microsoft Windows Server 2008, Enterprise x64 Edition
- Microsoft Windows Server 2008, Standard x64 Edition
- Microsoft Windows Server 2008, Standard x86 Edition
- Microsoft Windows Server 2008, Web x64 Edition
- Microsoft Windows Server 2008, Web x86 Edition
- Microsoft Windows Server 2012
- Microsoft Windows Server 2012 R2
- Red Hat Enterprise Linux 5 Server Edition
- Red Hat Enterprise Linux 5 Server with Xen x64 Edition
- Red Hat Enterprise Linux 5 Server x64 Edition
- Red Hat Enterprise Linux 6 Server Edition
- Red Hat Enterprise Linux 6 Server x64 Edition
- Red Hat Enterprise Linux 7
- SUSE LINUX Enterprise Server 11 for x86
- SUSE LINUX Enterprise Server 11 with Xen for AMD64/EM64T
- SUSE Linux Enterprise Server 12
- SUSE Linux Enterprise Server 12 with XEN
- VMware vSphere 5.0 (ESXi)

- VMware vSphere 5.1 (ESXi)
- VMware vSphere 5.5 (ESXi)

For the latest information about the specific versions and service levels supported and any other prerequisites, see the ServerProven® website at:

<http://www.lenovo.com/us/en/serverproven/nos/matrix.shtml>

Physical specifications

The server has the following dimensions and weight (approximate):

- Height: 86 mm (3.4 in.)
- Width: 447 mm (17.6 in.)
- Depth: 749 mm (29.5 in.)
- Weight:
 - Minimum configuration: 16.4 kg (36.2 lb).
 - Maximum configuration: 28.2 kg (62.2 lb).

Operating environment

The server is supported in the following environment:

- Air temperature
 - Server on: 5 °C - 40 °C (41.0 °F - 104 °F); altitude: 0 - 915 m (3,000 ft).
 - Server on: 5 °C - 32 °C (41.0 °F - 89.6 °F); altitude: 915 - 2,134 m (7,000 ft).
 - Server on: 5 °C - 28 °C (41.0 °F - 82.4 °F); altitude: 2,134 - 3,050 m (10,000 ft).
 - Server off: 5 °C - 45 °C (41.0 °F - 113 °F).
 - Shipment: -40 °C - 60 °C (-40 °F - 140 °F).
- Humidity:
 - Server on: 8% - 85%, maximum dew point 24 °C, maximum rate of change 5 °C/hr.
 - Server off: 8% - 80%, maximum dew point 27 °C.
 - Shipment: 5% - 100%.
- Design to ASHRAE Class A3, ambient of 35 °C - 40 °C, with relaxed support:
 - Support cloud like workload with no performance degradation acceptable (Turbo-Off).
 - Under no circumstance can any combination of worst case workload and configuration result in system shutdown or design exposure at 40 °C.
- Electrical
 - Models with 900 W AC hot-swap power supplies:
 - 100 to 127 (nominal) V ac; 50 Hz or 60 Hz; 10 A
 - 200 to 240 (nominal) V ac; 50 Hz or 60 Hz; 5 A
 - Input kilovolt-amperes (kVA) (approximately):
 - Minimum configuration: 0.14 kVA
 - Maximum configuration: 0.99 kVA
 - Models with 750 W AC hot-swap power supplies:
 - 100 - 127 (nominal) V AC; 50 Hz or 60 Hz; 8.9 A
 - 200 - 240 (nominal) V AC; 50 Hz or 60 Hz; 4.5 A
 - Input kilovolt-amperes (kVA) (approximately):
 - Minimum configuration: 0.14 kVA
 - Maximum configuration: 0.85 kVA
 - Models with 550 W AC hot-swap power supplies:
 - 100 - 127 (nominal) V AC; 50 Hz or 60 Hz; 6.5 A
 - 200 - 240 (nominal) V AC; 50 Hz or 60 Hz; 3.3 A
 - Input kilovolt-amperes (kVA) (approximately):
 - Minimum configuration: 0.12 kVA
 - Maximum configuration: 0.66 kVA

- Models with 750 W DC hot-swap power supplies:
 - -40 to -75 (nominal) V DC; 20.4 A
 - Input kilovolt-amperes (kVA) (approximately):
 - Minimum configuration: 0.14 kVA
 - Maximum configuration: 0.77 kVA
- BTU output
 - Minimum configuration: 406 Btu/hr (119 watts)
 - Maximum configuration: 3381 Btu/hr (990 watts)
- Noise level
 - 6.6 bels (operating).
 - 6.6 bels (idle).

Warranty options

The x3630 M4 has a three-year warranty with 24x7 standard call center support and 9x5 Next Business Day onsite coverage. Also available are Lenovo Services warranty maintenance upgrades and post-warranty maintenance agreements, with a well-defined scope of services, including service hours, response time, term of service, and service agreement terms and conditions.

Lenovo warranty service upgrade offerings are country-specific. Not all warranty service upgrades are available in every country. For more information about Lenovo warranty service upgrade offerings that are available in your country, visit the Lenovo Services website:

<https://www-304.ibm.com/sales/gss/download/spst/servicepac>

The following table explains warranty service definitions in more detail.

Table 24. Warranty service definitions

Term	Description
On-site service	A service technician will arrive at the client's location for equipment service.
24x7x2 hour	A service technician is scheduled to arrive at the client's location within two hours after remote problem determination is completed. Lenovo provides service around the clock, every day, including Lenovo holidays.
24x7x4 hour	A service technician is scheduled to arrive at the client's location within four hours after remote problem determination is completed. Lenovo provides service around the clock, every day, including Lenovo holidays.
9x5x4 hour	A service technician is scheduled to arrive at the client's location within four business hours after remote problem determination is completed. Lenovo provides service 8:00 am - 5:00 pm in the client's local time zone, Monday-Friday, excluding Lenovo holidays. For example, if a customer reports an incident at 3:00 pm on Friday, the technician will arrive by 10:00 am the following Monday.
9x5 next business day	A service technician is scheduled to arrive at the client's location on the business day after remote problem determination is completed. Lenovo provides service 8:00 am - 5:00 pm in the client's local time zone, Monday - Friday, excluding Lenovo holidays. Calls received after 4:00 pm local time require an extra business day for service dispatch. Next business day service is not guaranteed.
Committed Repair	Problems receive priority handling so that repairs are completed within the committed time of 6, 8, or 24 hours. Lenovo provides service 24 hours/day, every day, including Lenovo holidays.

The following Lenovo warranty service upgrades are available:

- Warranty and maintenance service upgrades:
 - Three, four, or five years of 9x5 or 24x7 service coverage
 - Onsite response from next business day to 2 or 4 hours
 - Committed repair service
 - Warranty extension of up to 5 years
 - Post warranty extensions
- Committed Repair Service
Committed Repair Services enhances the level of Warranty Service Upgrade or Post Warranty/Maintenance Service offering associated with the selected systems. Offerings vary and are available in select countries.
 - Priority handling to meet defined time frames to restore the failing machine to good working condition
 - Committed repair service levels are measured within the following coverage hours:
 - 24x7x6: Service performed 24 hours per day, 7 days per week, within 6 hours
 - 24x7x8: Service performed 24 hours per day, 7 days per week, within 8 hours
 - 24x7x24: Service performed 24 hours per day, 7 days per week, within 24 hours
- Hard Drive Retention
Lenovo's Hard Drive Retention service is a multi-drive hard drive retention offering that ensures your data is always under your control, regardless of the number of hard drives that are installed in your Lenovo server. In the unlikely event of a hard drive failure, you retain possession of your hard drive while Lenovo replaces the failed drive part. Your data stays safely on your premises, in your hands. The Hard Drive Retention service can be purchased in convenient bundles with our warranty upgrades and extensions.
- Microcode Support
Keeping microcode current helps prevent hardware failures and security exposure. There are two levels of service: analysis of the installed base and analysis and update where required. Offerings vary by country and can be bundled with other warranty upgrades and extensions.
- Remote Technical Support Services (RTS)
RTS provides comprehensive technical call center support for covered servers, storage, operating systems, and applications. Providing a single source for support of hardware and software issues, RTS can reduce problem resolution time, decreasing the cost to address technical problems and increasing uptime. Offerings are available for Windows, Linux, IBM Systems Director, VMware, Microsoft business applications, and Lenovo System x storage devices, and IBM OEM storage devices.

Regulatory compliance

The server conforms to the following regulations:

- FCC - Verified to comply with Part 15 of the FCC Rules, Class A
- Canada ICES-003, issue 4, Class A
- UL/IEC 60950-1
- CSA C22.2 No. 60950-1
- NOM-019
- Argentina IEC60950-1
- Japan VCCI, Class A
- Australia/New Zealand AS/NZS CISPR 22, Class A
- IEC 60950-1(CB Certificate and CB Test Report)
- China CCC (GB4943), GB9254 Class A, GB17625.1
- Taiwan BSMI CNS13438, Class A; CNS14336-1
- Korea KN22, Class A; KN24
- Russia, Belorussia and Kazakhstan, TR CU 020/2011 (for EMC) and TR CU 004/2011 (for safety)

- CE Mark (EN55022 Class A, EN60950-1, EN55024, EN61000-3-2, and EN61000-3-3)
- CISPR 22, Class A
- TUV-GS (EN60950-1 /IEC60950-1,EK1-ITB2000)

External disk storage expansion

The x3630 M4 supports attachments to the external storage expansion enclosures using the RAID controllers that are listed in the following table.

Table 25. Ordering part numbers and feature codes

Part number	Feature code	Description	Maximum supported
Adapters			
00AE938	A5ND	ServeRAID M5225-2GB SAS/SATA Controller	4
81Y4478	A1WX	ServeRAID M5120 SAS/SATA Controller	4
Hardware upgrades for the M5120#			
81Y4484	A1J3	ServeRAID M5100 Series 512MB Cache/RAID 5 Upgrade	4
81Y4487	A1J4	ServeRAID M5100 Series 512MB Flash/RAID 5 Upgrade	2*
81Y4559	A1WY	ServeRAID M5100 Series 1GB Flash/RAID 5 Upgrade	2*
47C8670	A4G6	ServeRAID M5100 Series 2GB Flash/RAID 5 Upgrade	1
81Y4508	A22E	ServeRAID M5100 Series Battery Kit	2*
Features on Demand (FoD) upgrades for the M5120			
81Y4546	A1X3	ServeRAID M5100 Series RAID 6 Upgrade	1**
90Y4273	A2MC	ServeRAID M5100 Series SSD Performance Accelerator	1**
90Y4318	A2MD	ServeRAID M5100 Series SSD Caching Enabler	1**

One of the available cache upgrades (81Y4484, 81Y4487, 81Y4559, or 47C8670) is required for the M5120 adapter.

* Total number of all Flash Upgrades and Battery Kits installed in a single server must not exceed two.

** One M5100 Series FoD software license activates the feature on all M5100 series controllers installed in a server.

The ServeRAID M5120 SAS/SATA Controller has the following specifications:

- Eight external 6 Gbps SAS/SATA ports; up to 6 Gbps throughput per port
- Two external x4 mini-SAS connectors (SFF-8088)
- Supports RAID levels 0, 1, and 10
- Supports RAID levels 5 and 50 with optional M5100 Series RAID 5 upgrades
- Supports RAID 6 and 60 with the optional M5100 Series RAID 6 Upgrade
- Supports 512 MB battery-backed cache or 512 MB, 1 GB, or 2 GB flash-backed cache (cache)
- PCIe 3.0 x8 host interface
- Based on the LSI SAS2208 6 Gbps ROC controller
- Supports connectivity to the EXP2512 and EXP2524 storage expansion enclosures

For more information, see the Lenovo Press Product Guide *ServeRAID M5120 SAS/SATA Controller*: <http://lenovopress.com/tips0858>

The ServeRAID M5225-2GB SAS/SATA Controller has the following specifications:

- Eight external 12 Gbps SAS/SATA ports
- Two external x4 mini-SAS HD connectors (SFF-8643)
- Supports RAID levels 0, 1, 10, 5, 50 standard
- 2 GB flash-backed cache standard
- PCIe x8 3.0 host interface
- Based on the LSI SAS3108 12 Gbps ROC controller

For more information about the ServeRAID M5225, see the Lenovo Press Product Guide at <http://lenovopress.com/tips1258>

The M5120 supports connectivity to the external expansion enclosures that are listed in the following table. Up to nine expansion enclosures can be daisy-chained per one adapter port. For better performance, distribute expansion enclosures evenly across both adapter ports.

Table 26. External expansion enclosures

Part number	Description	Maximum quantity supported per one M5120
70F0 / 70F1	Lenovo ThinkServer SA120	8
610012X	EXP2512 Storage Enclosure	17
610024X	EXP2524 Storage Enclosure	9

Lenovo ThinkServer SA120 support

For details about supported drives and cables for the Lenovo ThinkServer SA120, see the Lenovo Press Product Guide: <http://lenovopress.com/tips1234>

EXP2512 and EXP2524 support

The external SAS cables listed in the following table support connectivity between external expansion enclosures and the controller.

Table 27. External SAS cables for external storage expansion enclosures

Part number	Description	Maximum quantity supported per one enclosure
ServeRAID M5120 - Server to Expansion enclosure connectivity (Mini-SAS x4 to Mini-SAS x4)		
00WC017	1 m SAS Cable	1
00WC018	3 m SAS Cable	1
ServeRAID M5225 - Server to Expansion enclosure connectivity (Mini-SAS HD x4 to Mini-SAS x4)		
00MJ162	0.6m SAS Cable (mSAS HD to mSAS)	1
00MJ163	1.5m SAS Cable (mSAS HD to mSAS)	1
00MJ166	3m SAS Cable (mSAS HD to mSAS)	1
Expansion enclosure to Expansion enclosure connectivity (Mini-SAS x4 to Mini-SAS x4)		
00WC017	1 m SAS Cable	1
00WC018	3 m SAS Cable	1

The following table lists the drives that are supported by EXP2512 external expansion enclosures.

Table 28. Drive options for EXP2512 external expansion enclosures

Part number	Description	Maximum quantity supported per one enclosure
3.5" NL SAS HS HDDs		
00NC555	2TB 7,200 rpm 6Gb SAS NL 3.5" HDD	12
00NC557	3TB 7,200 rpm 6Gb SAS NL 3.5" HDD	12
00NC559	4TB 7,200 rpm 6Gb SAS NL 3.5" HDD	12

The following table lists the hard disk drives that are supported by EXP2524 external expansion enclosures.

Table 29. Drive options for EXP2524 external expansion enclosures

Part number	Description	Maximum quantity supported per one enclosure
2.5" NL SAS HS HDDs		
00NC571	1TB 7,200 rpm 6Gb SAS NL 2.5" HDD	24
2.5" SAS HS HDDs		
00NC561	146GB 15,000 rpm 6Gb SAS 2.5" HDD	24
00NC563	300GB 15,000 rpm 6Gb SAS 2.5" HDD	24
00NC565	600GB 10,000 rpm 6Gb SAS 2.5" HDD	24
00NC567	900GB 10,000 rpm 6Gb SAS 2.5" HDD	24
00NC569	1.2TB 10,000 rpm 6Gb SAS 2.5" HDD	24
2.5" SAS HS SSDs		
00NC573	200GB 6Gb SAS 2.5" SSD	24
00NC575	400GB 6Gb SAS 2.5" SSD	24

External disk storage systems

The following table lists the external storage systems that are offered by Lenovo that can be used in x3630 M4 solutions.

Table 30. External disk storage systems

Part number	Description
Lenovo Storage S2200	
64112B1	Lenovo Storage S2200 LFF Chassis SAS Single Controller, Rack Kit, 9x5NBD
64112B2	Lenovo Storage S2200 LFF Chassis SAS Dual Controller, Rack Kit, 9x5NBD
64114B1	Lenovo Storage S2200 LFF Chassis FC/iSCSI Single Controller, Rack Kit, 9x5NBD
64114B2	Lenovo Storage S2200 LFF Chassis FC/iSCSI Dual Controller, Rack Kit, 9x5NBD
64112B3	Lenovo Storage S2200 SFF Chassis SAS Single Controller, Rack Kit, 9x5NBD
64112B4	Lenovo Storage S2200 SFF Chassis SAS Dual Controller, Rack Kit, 9x5NBD
64114B3	Lenovo Storage S2200 SFF Chassis FC/iSCSI Single Controller, Rack Kit, 9x5NBD
64114B4	Lenovo Storage S2200 SFF Chassis FC/iSCSI Dual Controller, Rack Kit, 9x5NBD

Part number	Description
Lenovo Storage S3200	
64113B1	Lenovo Storage S3200 LFF Chassis SAS Single Controller, Rack Kit, 9x5NBD
64113B2	Lenovo Storage S3200 LFF Chassis SAS Dual Controller, Rack Kit, 9x5NBD
64116B1	Lenovo Storage S3200 LFF Chassis FC/iSCSI Single Controller, Rack Kit, 9x5NBD
64116B2	Lenovo Storage S3200 LFF Chassis FC/iSCSI Dual Controller, Rack Kit, 9x5NBD
64113B3	Lenovo Storage S3200 SFF Chassis SAS Single Controller, Rack Kit, 9x5NBD
64113B4	Lenovo Storage S3200 SFF Chassis SAS Dual Controller, Rack Kit, 9x5NBD
64116B3	Lenovo Storage S3200 SFF Chassis FC/iSCSI Single Controller, Rack Kit, 9x5NBD
64116B4	Lenovo Storage S3200 SFF Chassis FC/iSCSI Dual Controller, Rack Kit, 9x5NBD
IBM Storwize	
6096CU2	IBM Storwize V3500 3.5-inch Dual Control Storage Controller Unit
6096CU3	IBM Storwize V3500 2.5-inch Dual Control Storage Controller Unit
6099L2C	IBM Storwize V3700 3.5-inch Storage Controller Unit
6099S2C	IBM Storwize V3700 2.5-inch Storage Controller Unit
6099T2C	IBM Storwize V3700 2.5-inch DC Storage Controller Unit
6194L2C	IBM Storwize V5000 LFF Control Enclosure
6194S2C	IBM Storwize V5000 SFF Control Enclosure
6195SC5	IBM Storwize V7000 2.5-inch Storage Controller Unit

For more information, see the list of Product Guides in the following categories:

- Lenovo Storage
<https://lenovopress.com/storage/san/lenovo>
- IBM Storage
<https://lenovopress.com/storage/san/ibm>

External backup units

The following table lists the external backup options that are offered by Lenovo that can be used in x3630 M4 solutions.

Table 31. External backup options

Part number	Description
External tape enclosures	
61901UX	IBM Multimedia Backup Enclosure
Backup drives for IBM Multimedia Backup Enclosure	
00NV402	6190 HH LTO5 SAS Tape Drive
00NV404	6190 HH LTO6 SAS Tape Drive
00NV406	6190 RDX 3.0 Dock/320GB Cartridge Bundle
00NV407	6190 RDX 3.0 Dock/500GB Cartridge Bundle
00NV408	6190 RDX 3.0 Dock/1.0TB Cartridge Bundle
00NV455	6190 RDX 3.0 Dock/2.0TB Cartridge Bundle
External backup units	
362532Y	RDX External USB 3.0 Dock with 320GB Cartridge

Part number	Description
362550Y	RDX External USB 3.0 Dock with 500GB Cartridge
36251TY	RDX External USB 3.0 Dock with 1TB Cartridge
6160S6X	IBM TS2360 Tape Drive Model S63
6160S6E	IBM TS2260 Tape Drive Model H6S
6160S5E	IBM TS2250 Tape Drive Model H5S
6171S4R	IBM TS2900 Tape Autoloader w/LTO4 HH SAS
6171S5R	IBM TS2900 Tape Autoloader w/LTO5 HH SAS
6171S6R	IBM TS2900 Tape Autoloader w/LTO6 HH SAS
61732UL	IBM TS3100 Tape Library Model L2U
61734UL	IBM TS3200 Tape Library Model L4U
Fibre Channel backup drives for TS3100 and TS3200 Tape Libraries	
00NA101	6173 LTO Ultrium 4 Fibre Channel Drive Sled
00NA103	6173 LTO Ultrium 4 Half High Fibre Drive Sled
00NA107	6173 LTO Ultrium 5 Fibre Channel Drive
00NA113	6173 LTO Ultrium 5 Half High Fibre Drive Sled
00NA115	6173 LTO Ultrium 6 Fibre Channel Drive
00NA119	6173 LTO Ultrium 6 Half High Fibre Drive Sled
SAS backup drives for TS3100 and TS3200 Tape Libraries	
00NA121	6173 LTO Ultrium 4 SAS Drive Sled
00NA105	6173 LTO Ultrium 4 Half High SAS DriveV2 Sled
00NA109	6173 LTO Ultrium 5 SAS Drive Sled
00NA111	6173 LTO Ultrium 5 Half High SAS Drive Sled
00NA117	6173 LTO Ultrium 6 Half High SAS Drive Sled

For more information, see the list of Product Guides in the Backup Units category:

<http://lenovopress.com/servers/options/backup>

Top-of-rack Ethernet switches

The following table lists the top-of-rack Ethernet switches that are offered by Lenovo that can be used in x3630 M4 solutions.

Table 32. Top-of-rack switches

Part number	Description
1 Gb Ethernet top-of-rack switches	
7159BAX	Lenovo RackSwitch G7028 (Rear to Front)
7159CAX	Lenovo RackSwitch G7052 (Rear to Front)
7159G52	Lenovo RackSwitch G8052 (Rear to Front)
10 Gb Ethernet top-of-rack switches	
7159BR6	Lenovo RackSwitch G8124E (Rear to Front)
7159G64	Lenovo RackSwitch G8264 (Rear to Front)
7159DRX	Lenovo RackSwitch G8264CS (Rear to Front)
7159CRW	Lenovo RackSwitch G8272 (Rear to Front)
7159GR6	Lenovo RackSwitch G8296 (Rear to Front)
40 Gb Ethernet top-of-rack switches	
7159BRX	Lenovo RackSwitch G8332 (Rear to Front)

For more information, see the list of Product Guides in the Top-of-rack switches category:
<http://lenovopress.com/servers/options/switches>

Uninterruptible power supply units

The following table lists the uninterruptible power supply (UPS) units that are offered by Lenovo that can be used in x3630 M4 solutions.

Table 33. Uninterruptible power supply units

Part number	Description
55941AX	RT1.5kVA 2U Rack or Tower UPS (100-125VAC)
55941KX	RT1.5kVA 2U Rack or Tower UPS (200-240VAC)
55942AX	RT2.2kVA 2U Rack or Tower UPS (100-125VAC)
55942KX	RT2.2kVA 2U Rack or Tower UPS (200-240VAC)
55943AX	RT3kVA 2U Rack or Tower UPS (100-125VAC)
55943KX	RT3kVA 2U Rack or Tower UPS (200-240VAC)
55945KX	RT5kVA 3U Rack or Tower UPS (200-240VAC)
55946KX	RT6kVA 3U Rack or Tower UPS (200-240VAC)
55948KX	RT8kVA 6U Rack or Tower UPS (200-240VAC)
55949KX	RT11kVA 6U Rack or Tower UPS (200-240VAC)
55948PX	RT8kVA 6U 3:1 Phase Rack or Tower UPS (380-415VAC)
55949PX	RT11kVA 6U 3:1 Phase Rack or Tower UPS (380-415VAC)

For more information, see the list of Product Guides in the Uninterruptible Power Supply Units category:
<http://lenovopress.com/servers/options/ups>

Power distribution units

The following table lists the power distribution units (PDUs) that are offered by Lenovo that can be used in x3630 M4 solutions.

Table 34. Power distribution units

Part number	Description
0U Basic PDUs	
46M4122	0U 24 C13 16A 3 Phase PDU with IEC 309 P+N+Gnd line cord
46M4125	0U 24 C13 30A 3 Phase PDU with NEMA L21-30P line cord
46M4128	0U 24 C13 30A PDU with NEMA L6-30P line cord
46M4131	0U 24 C13 32A PDU with IEC 309 P+N+Gnd line cord
46M4143	0U 12 C19/12 C13 32A 3 Phase PDU with IEC 309 3P+N+Gnd line cord
46M4140	0U 12 C19/12 C13 60A 3 Phase PDU with CS8365L 3P+Gnd line cord
Switched and Monitored PDUs	
46M4002	1U 9 C19/3 C13 Switched and Monitored DPI PDU (without line cord)
46M4003	1U 9 C19/3 C13 Switched and Monitored 60A 3 Phase PDU with IEC 309 3P+Gnd line cord
46M4004	1U 12 C13 Switched and Monitored DPI PDU (without line cord)
46M4005	1U 12 C13 Switched and Monitored 60A 3 Phase PDU with IEC 309 3P+Gnd line cord
46M4167	1U 9 C19/3 C13 Switched and Monitored 30A 3 Phase PDU with NEMA L21-30P line cord
46M4116	0U 24 C13 Switched and Monitored 30A PDU with NEMA L6-30P line cord
46M4119	0U 24 C13 Switched and Monitored 32A PDU with IEC 309 P+N+Gnd line cord
46M4137	0U 12 C19/12 C13 Switched and Monitored 32A 3 Phase PDU with IEC 309 3P+N+Gnd cord
46M4134	0U 12 C19/12 C13 Switched and Monitored 50A 3 Phase PDU with CS8365L 3P+Gnd cord
Ultra Density Enterprise PDUs (9x IEC 320 C13 + 3x IEC 320 C19 outlets)	
71762NX	Ultra Density Enterprise C19/C13 PDU Module (without line cord)
71762MX	Ultra Density Enterprise C19/C13 PDU+ Module (without line cord)
71763NU	Ultra Density Enterprise C19/C13 PDU 60A/208V/3ph with IEC 309 3P+Gnd line cord
71763MU	Ultra Density Enterprise C19/C13 PDU+ 60A/208V/3ph with IEC 309 3P+Gnd line cord
C13 Enterprise PDUs (12x IEC 320 C13 outlets)	
39M2816	DPI C13 Enterprise PDU+ (without line cord)
39Y8941	DPI Single Phase C13 Enterprise PDU (without line cord)
C19 Enterprise PDUs (6x IEC 320 C19 outlets)	
39Y8948	DPI Single Phase C19 Enterprise PDU (without line cord)
39Y8923	DPI 60A 3 Phase C19 Enterprise PDU with IEC 309 3P+G (208 V) fixed line cord
Front-end PDUs (3x IEC 320 C19 outlets)	
39Y8938	DPI 30amp/125V Front-end PDU with NEMA L5-30P line cord
39Y8939	DPI 30amp/250V Front-end PDU with NEMA L6-30P line cord
39Y8934	DPI 32amp/250V Front-end PDU with IEC 309 2P+Gnd line cord
39Y8940	DPI 60amp/250V Front-end PDU with IEC 309 2P+Gnd line cord
39Y8935	DPI 63amp/250V Front-end PDU with IEC 309 2P+Gnd line cord
Universal PDUs (7x IEC 320 C13 outlets)	
39Y8951	DPI Universal Rack PDU with US LV and HV line cords

Part number	Description
39Y8952	DPI Universal Rack PDU with CEE7-VII Europe line cord
39Y8953	DPI Universal Rack PDU with Denmark line cord
39Y8954	DPI Universal Rack PDU with Israel line cord
39Y8955	DPI Universal Rack PDU with Italy line cord
39Y8956	DPI Universal Rack PDU with South Africa line cord
39Y8957	DPI Universal Rack PDU with UK line cord
39Y8958	DPI Universal Rack PDU with AS/NZ line cord
39Y8959	DPI Universal Rack PDU with China line cord
39Y8962	DPI Universal Rack PDU (Argentina)
39Y8960	DPI Universal Rack PDU (Brazil)
39Y8961	DPI Universal Rack PDU (India)
NEMA PDUs (6x NEMA 5-15R outlets)	
39Y8905	DPI 100-127V PDU with Fixed NEMA L5-15P line cord
Line cords for PDUs that ship without a line cord	
40K9611	DPI 32a Line Cord (IEC 309 3P+N+G)
40K9612	DPI 32a Line Cord (IEC 309 P+N+G)
40K9613	DPI 63a Cord (IEC 309 P+N+G)
40K9614	DPI 30a Line Cord (NEMA L6-30P)
40K9615	DPI 60a Cord (IEC 309 2P+G)
40K9617	DPI Australian/NZ 3112 Line Cord
40K9618	DPI Korean 8305 Line Cord

For more information, see the list of Product Guides in the Power Distribution Units category:
<http://lenovopress.com/servers/options/pdu>

Rack cabinets

The following table lists the rack cabinets that are offered by Lenovo that can be used in x3630 M4 solutions.

Table 35. Rack cabinets

Part number	Description
201886X	11U Rack Office Enablement Kit
93072RX	25U S2 Standard Rack
93072PX	25U Static S2 Standard Rack
93074RX	42U S2 Standard Rack
93634PX	42U 1100mm Enterprise V2 Dynamic Rack
93634EX	42U 1100mm Enterprise V2 Dynamic Expansion Rack
93604PX	42U 1200mm Deep Dynamic Rack
93614PX	42U 1200mm Deep Static Rack
93084PX	42U Enterprise Rack
93084EX	42U Enterprise Expansion Rack

For more information, see the list of Product Guides in the Rack cabinets category:
<http://lenovopress.com/servers/options/racks>

Rack options

The x3630 M4 server supports the rack options listed in the following table.

Table 36. Rack options

Description	Part number
Monitor kits and keyboard trays	
1U 18.5" Standard Console	17238BX
1U 18.5" Enhanced Media Console	17238EX
Console switches	
Global 4x2x32 Console Manager (GCM32)	1754D2X
Global 2x2x16 Console Manager (GCM16)	1754D1X
Local 2x16 Console Manager (LCM16)	1754A2X
Local 1x8 Console Manager (LCM8)	1754A1X
Console cables	
Single Cable USB Conversion Option (UCO)	43V6147
USB Conversion Option (4 Pack UCO)	39M2895
Virtual Media Conversion Option Gen2 (VCO2)	46M5383
Serial Conversion Option (SCO)	46M5382

For more information, see the list of Product Guides in the KVM Switches and Consoles category:
<http://lenovopress.com/servers/options/kvm>

Lenovo Financial Services

Lenovo Financial Services reinforces Lenovo's commitment to deliver pioneering products and services that are recognized for their quality, excellence, and trustworthiness. Lenovo Financial Services offers financing solutions and services that complement your technology solution anywhere in the world.

We are dedicated to delivering a positive finance experience for customers like you who want to maximize your purchase power by obtaining the technology you need today, protect against technology obsolescence, and preserve your capital for other uses.

We work with businesses, non-profit organizations, governments and educational institutions to finance their entire technology solution. We focus on making it easy to do business with us. Our highly experienced team of finance professionals operates in a work culture that emphasizes the importance of providing outstanding customer service. Our systems, processes and flexible policies support our goal of providing customers with a positive experience.

We finance your entire solution. Unlike others, we allow you to bundle everything you need from hardware and software to service contracts, installation costs, training fees, and sales tax. If you decide weeks or months later to add to your solution, we can consolidate everything into a single invoice.

Our Premier Client services provide large accounts with special handling services to ensure these complex transactions are serviced properly. As a premier client, you have a dedicated finance specialist who manages your account through its life, from first invoice through asset return or purchase. This specialist develops an in-depth understanding of your invoice and payment requirements. For you, this dedication provides a high-quality, easy, and positive financing experience.

For your region specific offers please ask your Lenovo sales representative or your technology provider about the use of Lenovo Financial Services. For more information, see the following Lenovo website: <http://www.lenovofs.com>

Related publications and links

For more information, see these resources:

- US Announcement Letter - System x3630 M4 (E5-2400 v2):
<http://ibm.com/common/ssi/cgi-bin/ssialias?infotype=dd&subtype=ca&&htmlfid=897/ENUS114-019>
- Lenovo Press Product Guides for servers and options:
<http://lenovopress.com>
- *System x3630 M4 Installation and User's Guide* :
- <http://ibm.com/support/entry/portal/docdisplay?Indocid=MIGR-5090171>
- *System x3630 M4 Problem Determination and Service Guide* :
<http://ibm.com/support/entry/portal/docdisplay?Indocid=MIGR-5090165>
- ServerProven hardware compatibility page for the x3630 M4:
<http://www.lenovo.com/us/en/serverproven/xseries/7158CE5CxxxV2.shtml>
- *Configuration and Option Guide* :
<http://www.ibm.com/systems/xbc/cog/>
- xREF - System x Reference Sheets:
<http://lenovopress.com/xref>
- System x3630 M4 Support Portal:
http://www.ibm.com/support/entry/portal/product/system_x/system_x3630_m4
- IBM System Storage Interoperation Center:
<http://www.ibm.com/systems/support/storage/ssic>

Related product families

Product families related to this document are the following:

- [2-Socket Rack Servers](#)

Notices

Lenovo may not offer the products, services, or features discussed in this document in all countries. Consult your local Lenovo representative for information on the products and services currently available in your area. Any reference to a Lenovo product, program, or service is not intended to state or imply that only that Lenovo product, program, or service may be used. Any functionally equivalent product, program, or service that does not infringe any Lenovo intellectual property right may be used instead. However, it is the user's responsibility to evaluate and verify the operation of any other product, program, or service. Lenovo may have patents or pending patent applications covering subject matter described in this document. The furnishing of this document does not give you any license to these patents. You can send license inquiries, in writing, to:

Lenovo (United States), Inc.
1009 Think Place - Building One
Morrisville, NC 27560
U.S.A.
Attention: Lenovo Director of Licensing

LENOVO PROVIDES THIS PUBLICATION "AS IS" WITHOUT WARRANTY OF ANY KIND, EITHER EXPRESS OR IMPLIED, INCLUDING, BUT NOT LIMITED TO, THE IMPLIED WARRANTIES OF NON-INFRINGEMENT, MERCHANTABILITY OR FITNESS FOR A PARTICULAR PURPOSE. Some jurisdictions do not allow disclaimer of express or implied warranties in certain transactions, therefore, this statement may not apply to you.

This information could include technical inaccuracies or typographical errors. Changes are periodically made to the information herein; these changes will be incorporated in new editions of the publication. Lenovo may make improvements and/or changes in the product(s) and/or the program(s) described in this publication at any time without notice.

The products described in this document are not intended for use in implantation or other life support applications where malfunction may result in injury or death to persons. The information contained in this document does not affect or change Lenovo product specifications or warranties. Nothing in this document shall operate as an express or implied license or indemnity under the intellectual property rights of Lenovo or third parties. All information contained in this document was obtained in specific environments and is presented as an illustration. The result obtained in other operating environments may vary. Lenovo may use or distribute any of the information you supply in any way it believes appropriate without incurring any obligation to you.

Any references in this publication to non-Lenovo Web sites are provided for convenience only and do not in any manner serve as an endorsement of those Web sites. The materials at those Web sites are not part of the materials for this Lenovo product, and use of those Web sites is at your own risk. Any performance data contained herein was determined in a controlled environment. Therefore, the result obtained in other operating environments may vary significantly. Some measurements may have been made on development-level systems and there is no guarantee that these measurements will be the same on generally available systems. Furthermore, some measurements may have been estimated through extrapolation. Actual results may vary. Users of this document should verify the applicable data for their specific environment.

© Copyright Lenovo 2019. All rights reserved.

This document, TIPS1145, was created or updated on December 9, 2015.

Send us your comments in one of the following ways:

- Use the online Contact us review form found at:
<http://lenovopress.com/TIPS1145>
- Send your comments in an e-mail to:
comments@lenovopress.com

This document is available online at <http://lenovopress.com/TIPS1145>.

Trademarks

Lenovo and the Lenovo logo are trademarks or registered trademarks of Lenovo in the United States, other countries, or both. A current list of Lenovo trademarks is available on the Web at <https://www.lenovo.com/us/en/legal/copytrade/>.

The following terms are trademarks of Lenovo in the United States, other countries, or both:

Lenovo Services

Lenovo®

RackSwitch

ServeRAID

ServerGuide

ServerProven®

System x®

ThinkServer®

The following terms are trademarks of other companies:

Intel® and Xeon® are trademarks or registered trademarks of Intel Corporation or its subsidiaries in the United States and other countries.

Linux® is a trademark of Linus Torvalds in the United States, other countries, or both.

Microsoft®, Windows Server®, and Windows® are trademarks of Microsoft Corporation in the United States, other countries, or both.

Other company, product, or service names may be trademarks or service marks of others.